



USER GUIDE



## MALE CATHETERIZATION TRAINER

This product is available  
in light and dark skin tones

60850

60870

FOR MORE SKILLS TRAINING PRODUCTS VISIT

[limbsandthings.com](https://limbsandthings.com)

Sussex Street, St Philips, Bristol, BS2 0RA, UK | [sales@limbsandthings.com](mailto:sales@limbsandthings.com) | +44 (0) 117 311 0500

PACKAGE SUPPLIED	3
SAFETY & CLEANING INSTRUCTIONS	4
SET UP	5
• PLACING PELVIC SHELL	5
• FITTING THE FORESKIN	6
• ASSEMBLING THE WATER SYSTEM	7
• EMPTYING WATER	9
• REASSEMBLY	10

TAKE A LOOK  
AT OUR **VIDEO**



VISIT THE WEBSITE  
[limbsandthings.com](https://limbsandthings.com)

OR YOUTUBE CHANNEL  
[youtube.com/limbsandthings](https://youtube.com/limbsandthings)

## PACKAGE SUPPLIED

Male Catheterization Module

60850

60874



Water System

60863

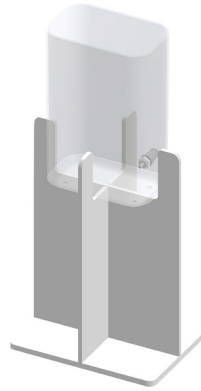

Pelvic Shell & Stand

60864

60881

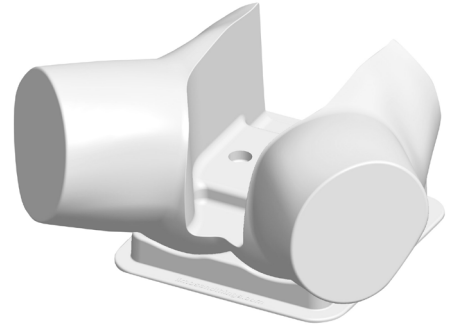

Catheterization Foreskins (x3)

60859

60878

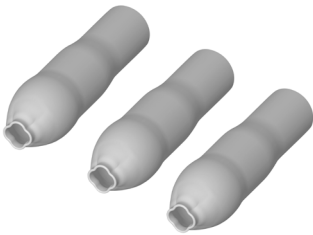

Aseptic Catheterization Sleeves (x2)

60862



Lubricant Gel with Syringe

60890

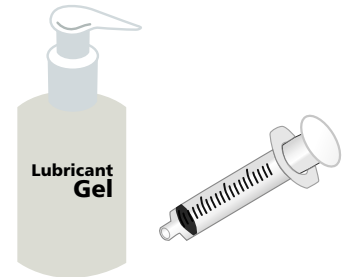

Antifungal Agent (Milton)

50185



Plastic Kidney Dish



14 French Foley Catheter

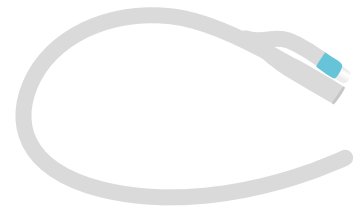

Water Extension Tubing

60867

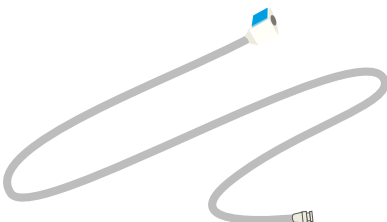

# SAFETY & CLEANING INSTRUCTIONS

READ THE SAFETY INSTRUCTIONS CAREFULLY BEFORE USING YOUR CATHETERIZATION TRAINER

## DO's



Follow all instructions. Keep these instructions. Heed all warnings.

Only use attachments/accessories specified by Limbs & Things.



Refer all servicing to qualified service personnel. Servicing is required when the apparatus has been damaged.

Wear gloves at all times and remove all jewellery items. Sharp surfaces such as finger nails and rings can lead to damage of silicone parts.



Use lubrication when inserting catheter.

Use only the Milton Antifungal agent supplied to sterilize water.



Use 14 French Foley catheter (male length).

Drain all water from the product and clean with a damp soft cloth or sponge, using only warm water with mild detergent.



## DON'Ts



Do not install near any heat sources, do not expose the product to flames or use near naked flame sources. Do not use flammable solvents near or on this product.

Do not set up the product near electrical appliances or items damaged by water.



Do not leave catheters inserted in the Trainer.

Do not attempt to remove a catheter which has an inflated balloon.



Do not use anaesthetic gel – use mock gel supplied with trainer.

Do not disassemble the product or attempt to repair a faulty unit, please return the product to Limbs & Things for assessment and repair.



## STORAGE & TRANSPORTATION



Always ensure that the product is properly packed and secured during transportation and storage in order to prevent personal injury or damage to the product.

1

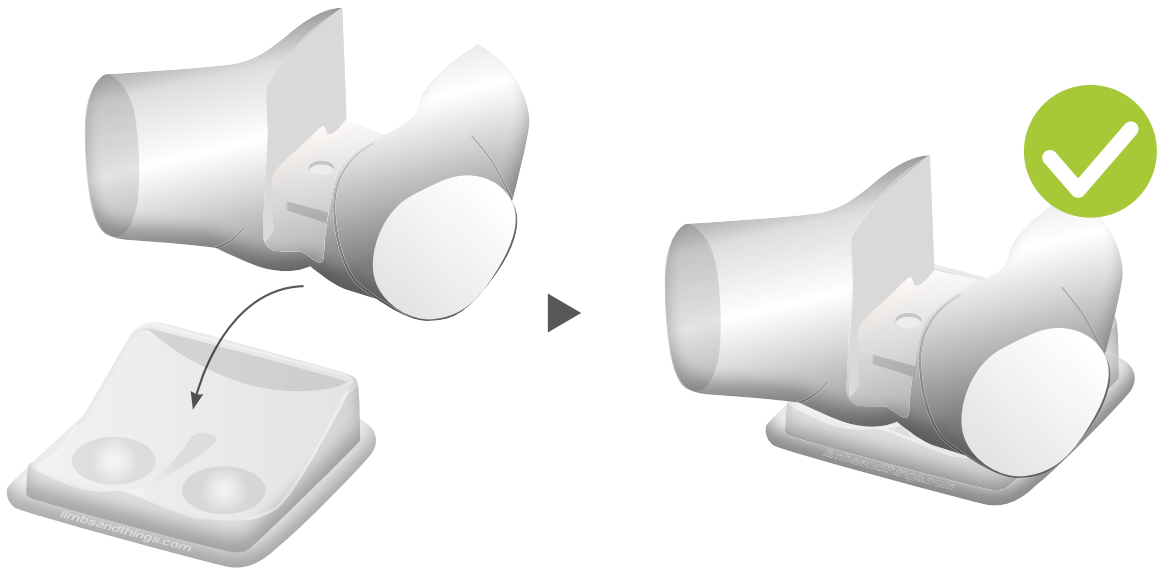

2

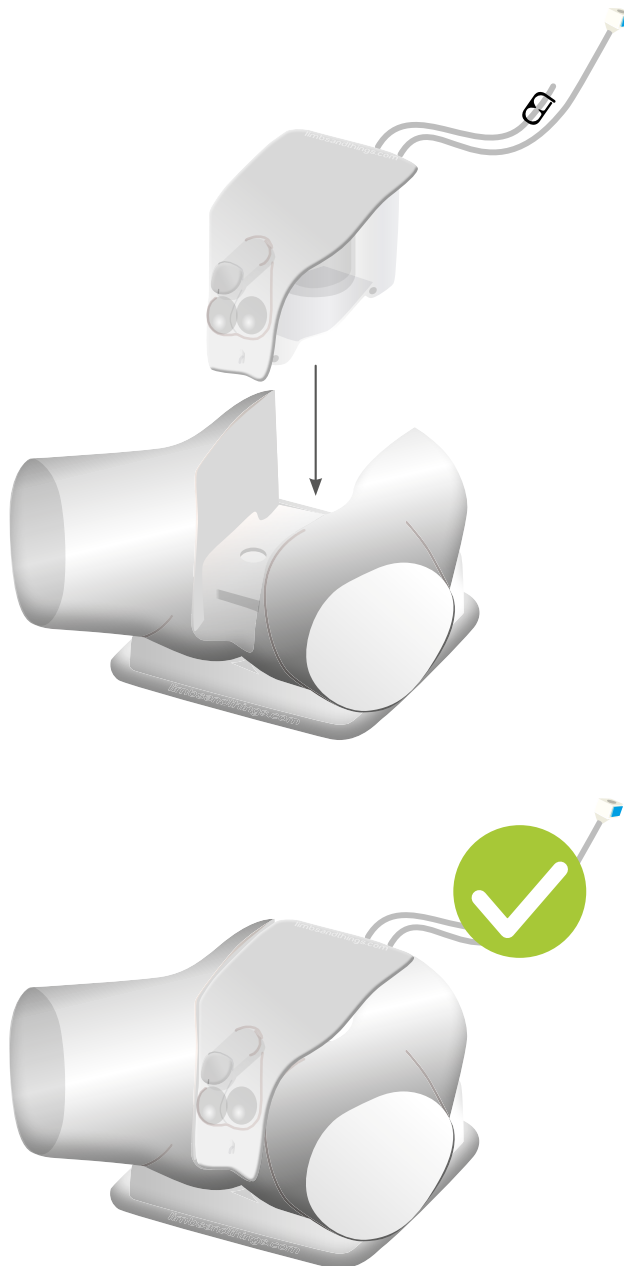

1

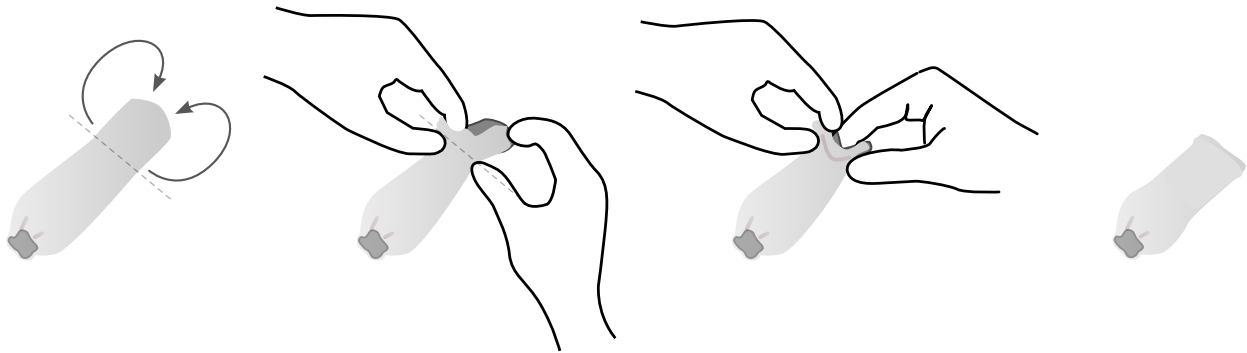

2

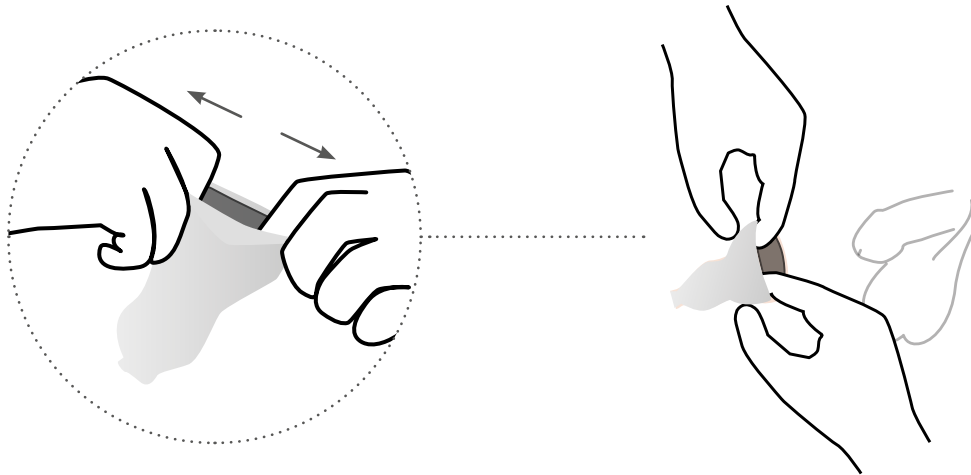

3

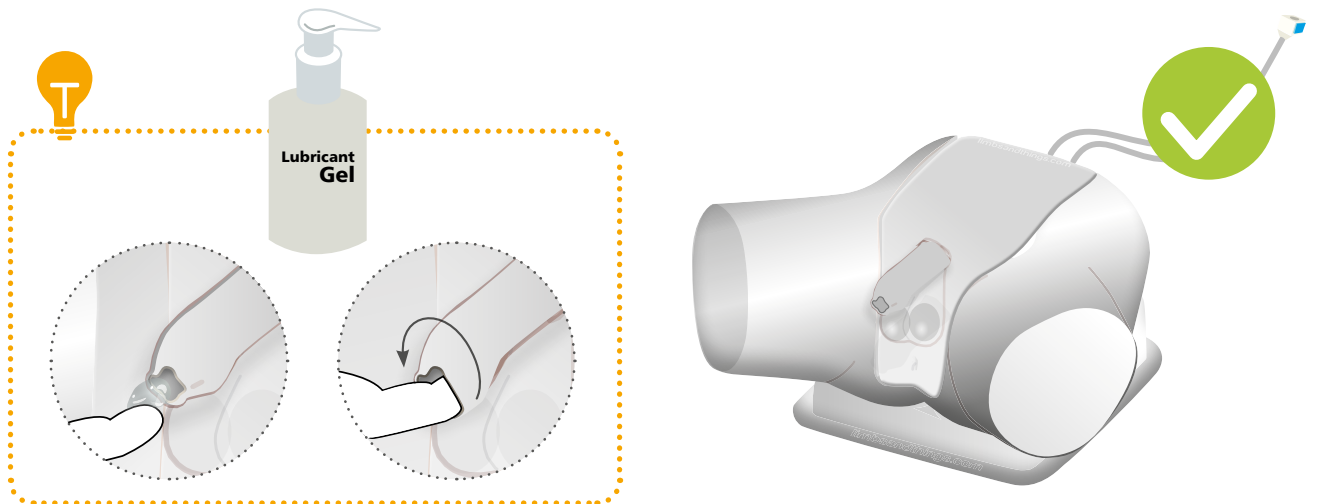

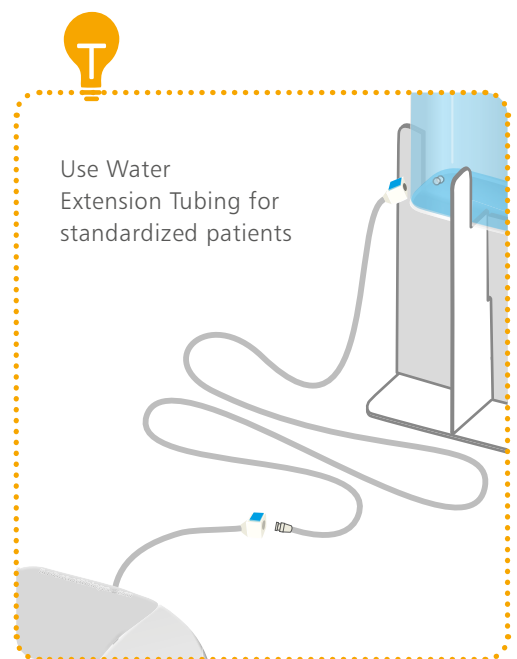
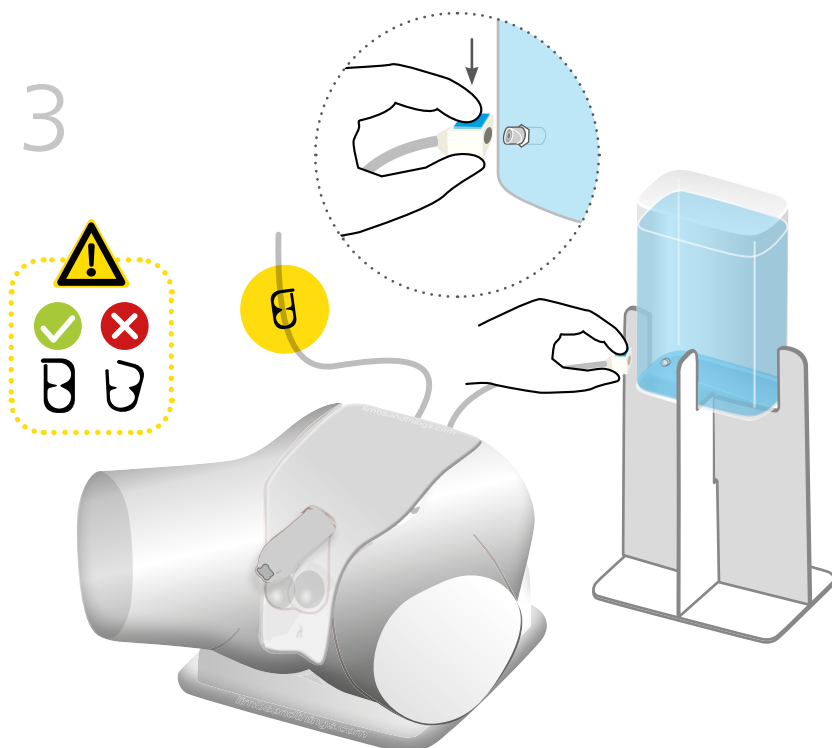
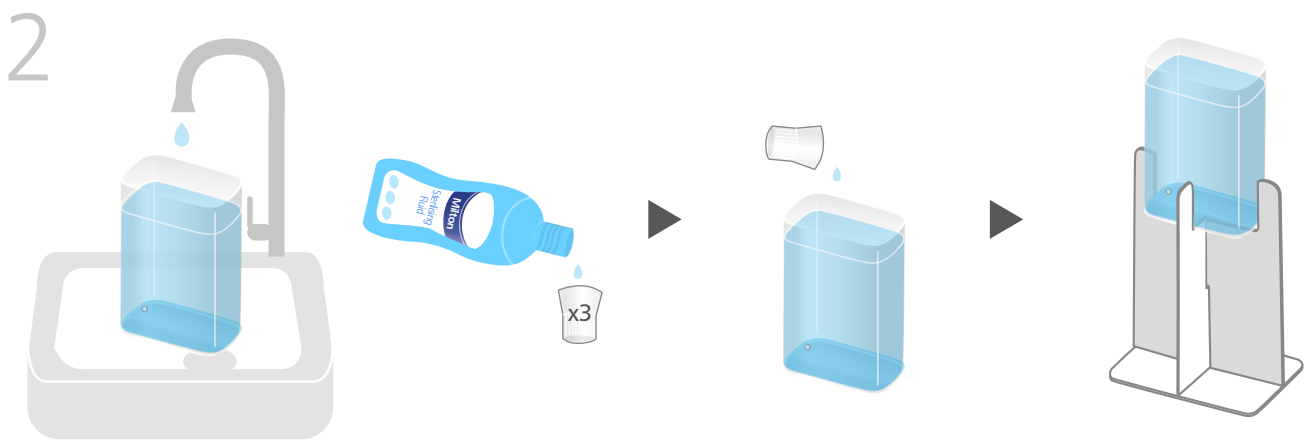
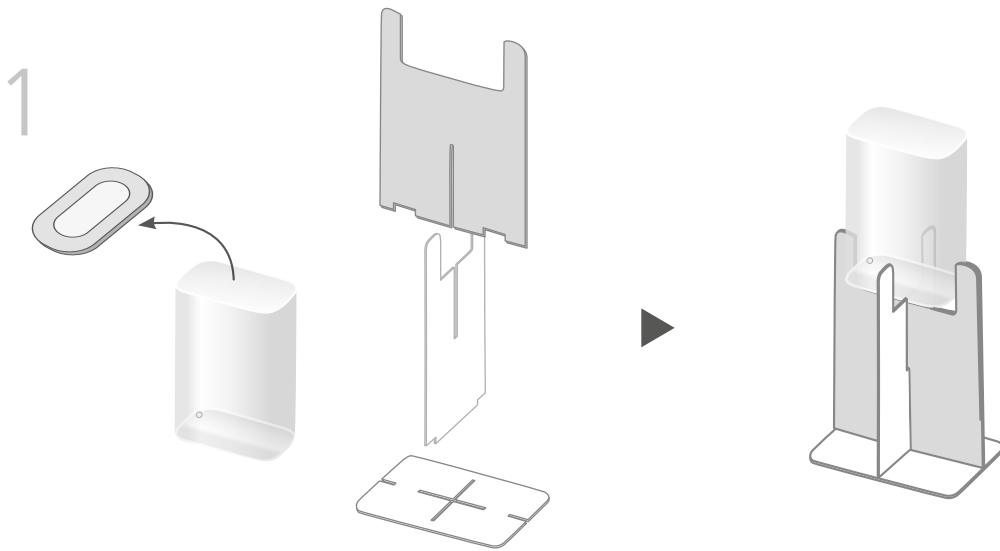

4

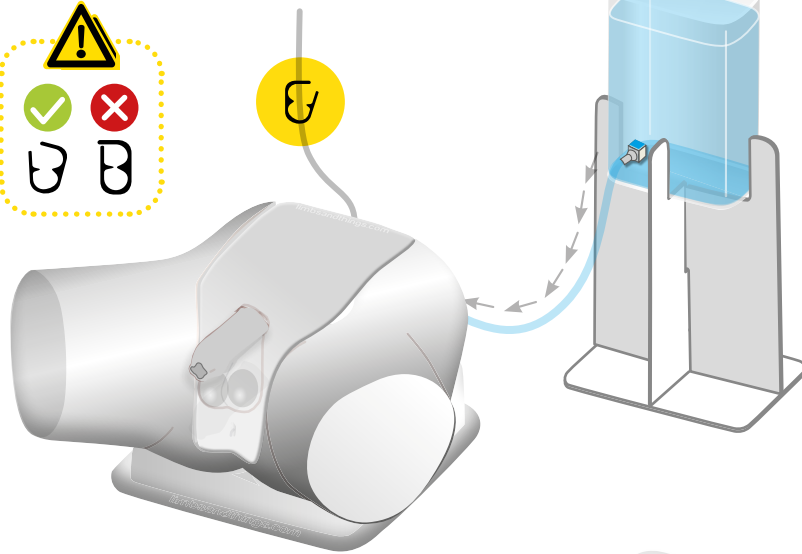

5

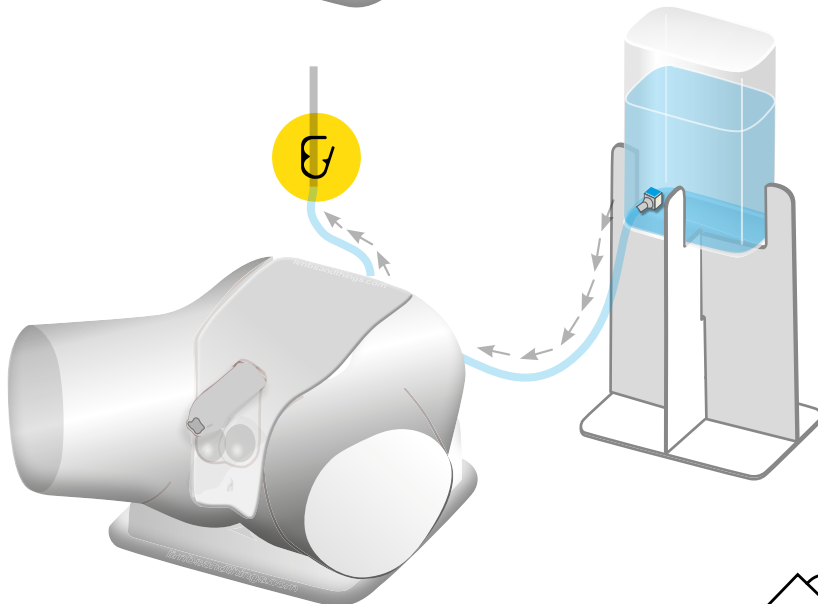

6



Keep water reservoir topped up

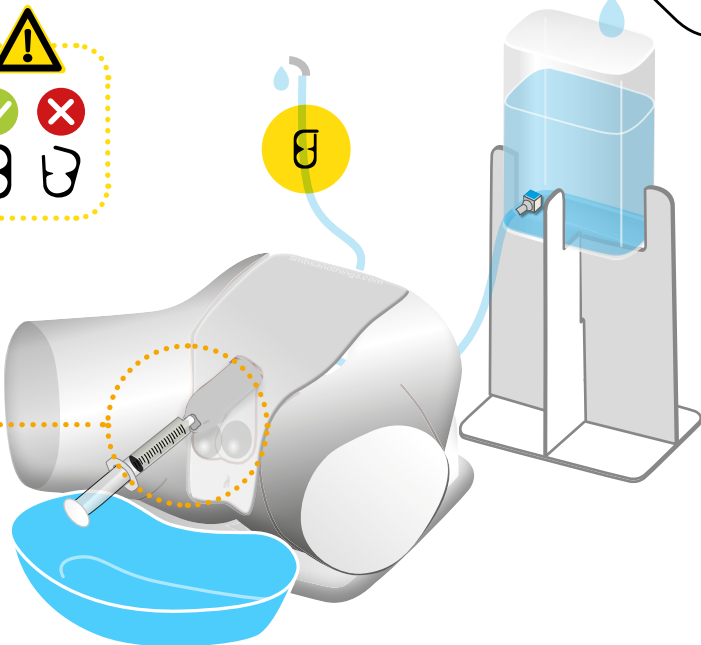



1

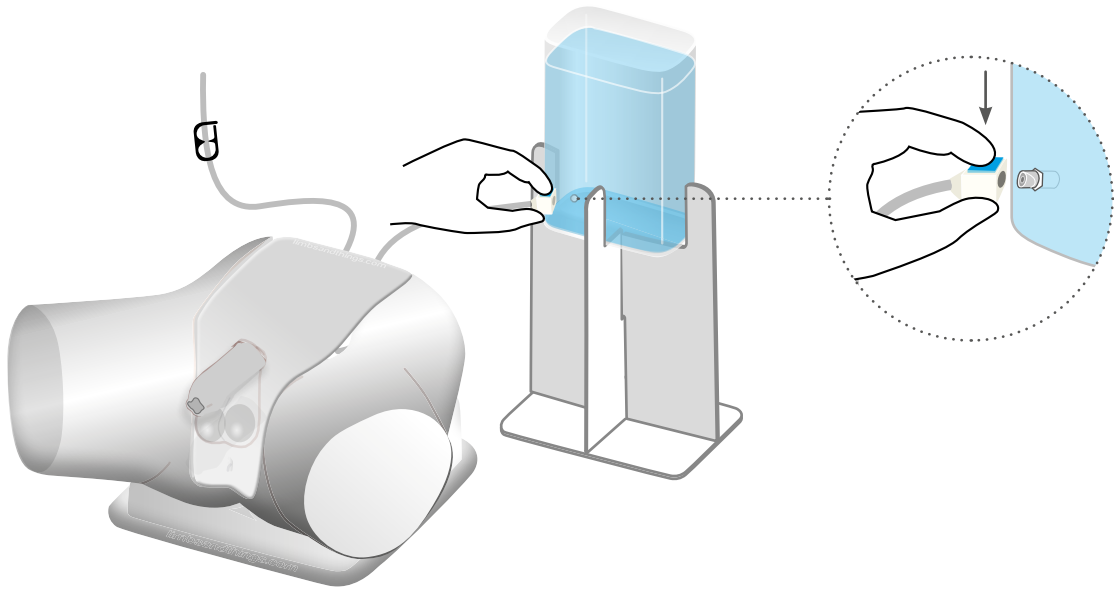

2

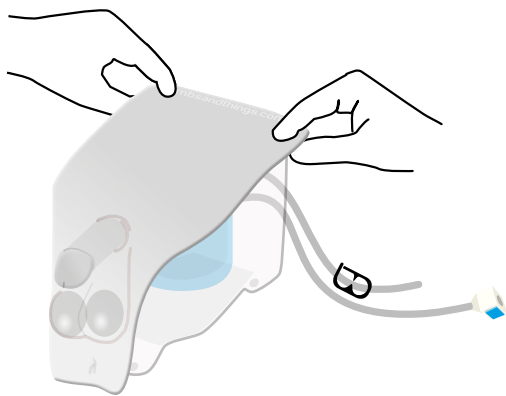

3

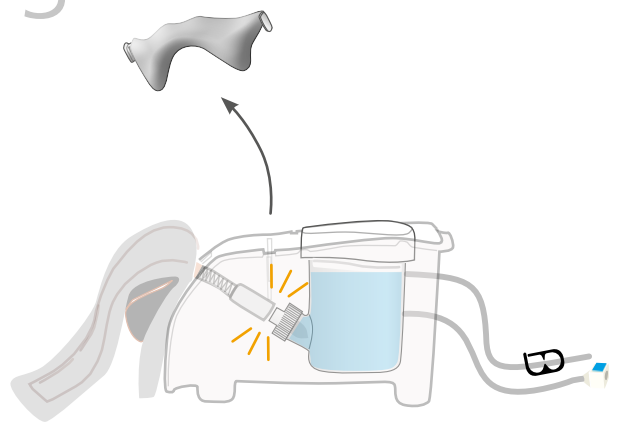

4

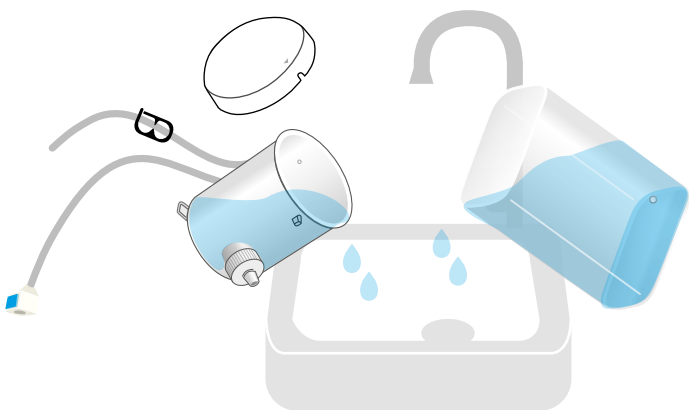

Dry all parts with paper towel  
Reassemble and put in box

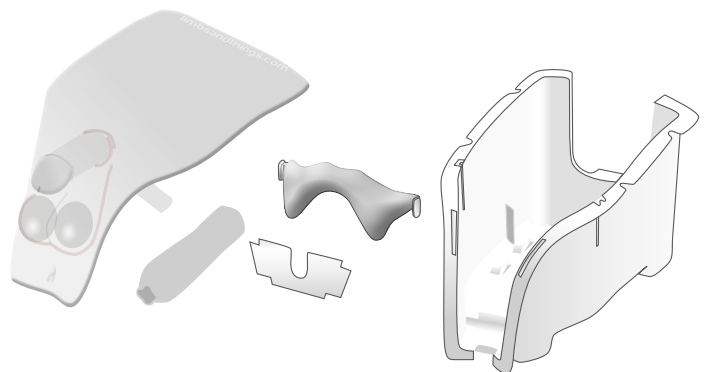

1

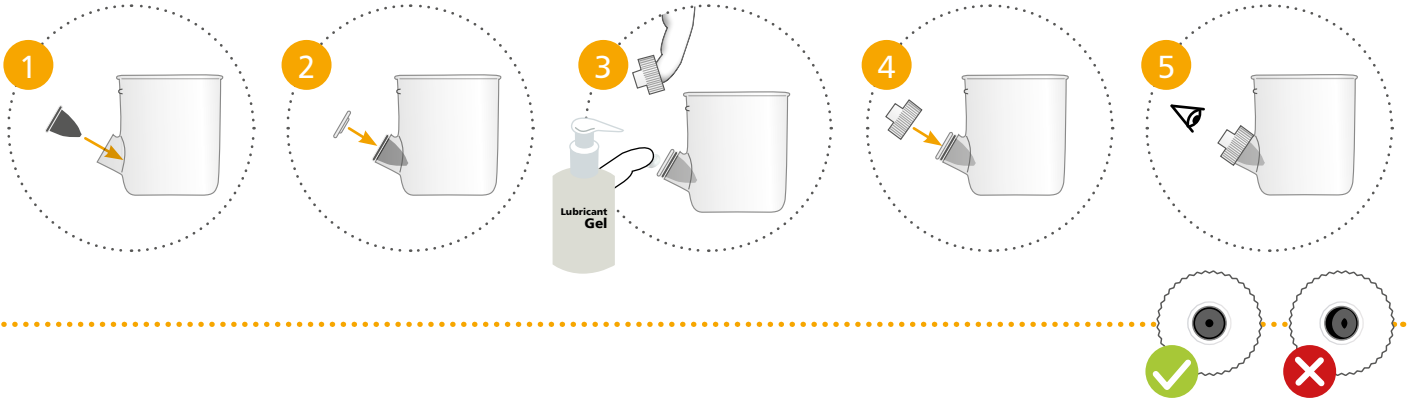
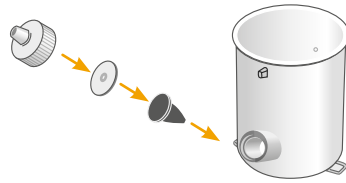

2

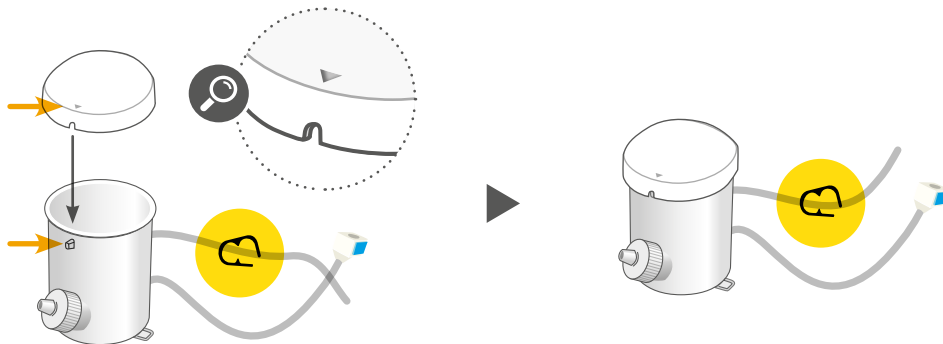

3

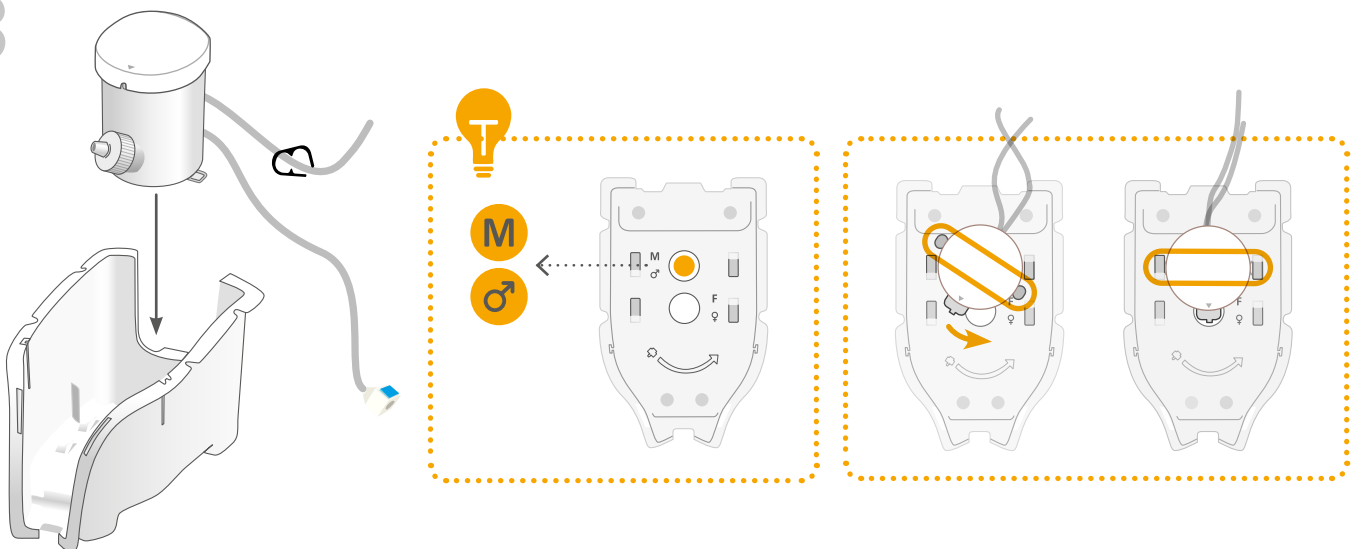

4

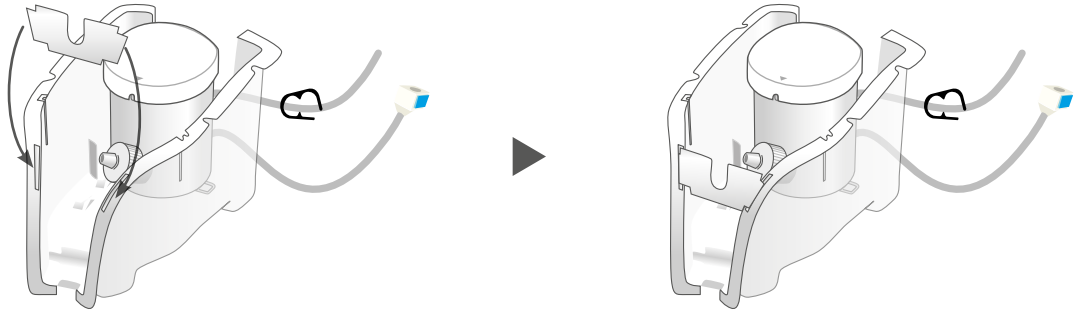

5

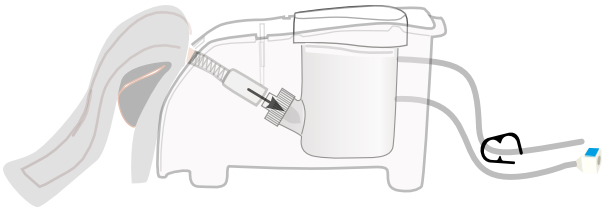

6

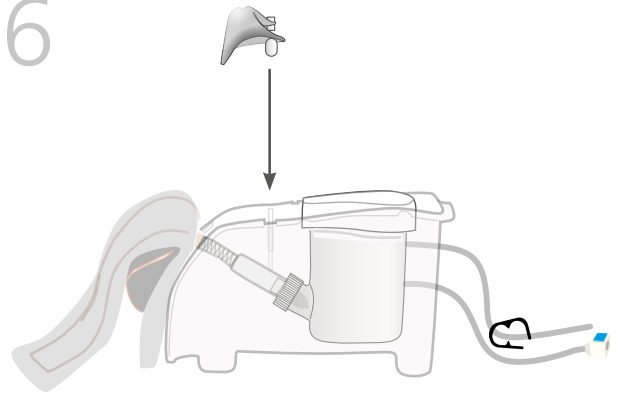

7

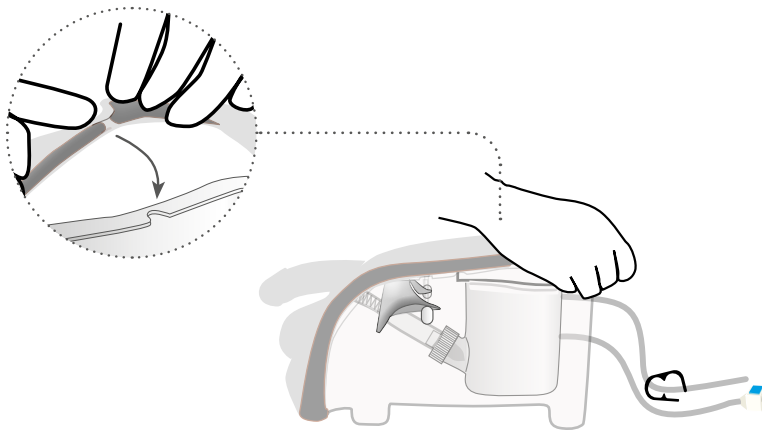

YOU MAY  
ALSO BE  
INTERESTED IN...

FEMALE  
CATHETERIZATION  
TRAINER

60851

60869

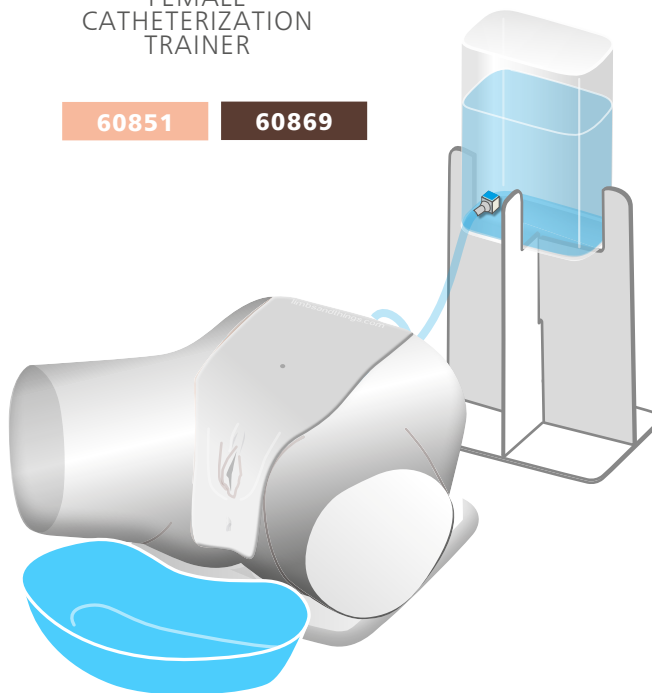

SUPRAPUBIC  
INSERTION UNIT

60852

60873

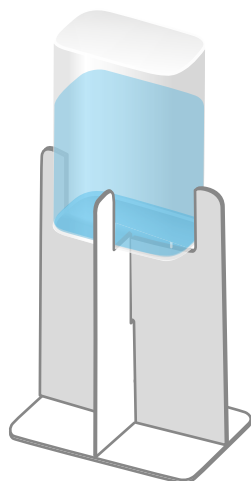
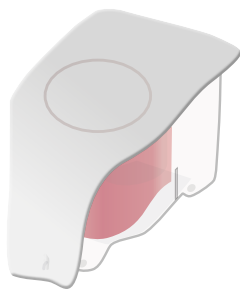

MEDIUM  
CARRY CASE

40209

