

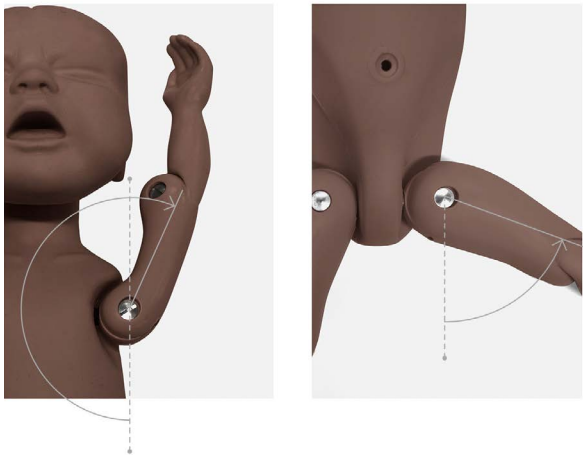

## USER GUIDE



# BIRTHING SIMULATOR PROMPT FLEX

STANDARD

This product is available  
in light and dark skin tones

80100

80200

FOR MORE SKILLS TRAINING PRODUCTS VISIT

[limbsandthings.com](https://limbsandthings.com)

Sussex Street, St Philips, Bristol, BS2 0RA, UK | [sales@limbsandthings.com](mailto:sales@limbsandthings.com) | +44 (0) 117 311 0500

# INDEX

PACKAGE SUPPLIED	3
SAFETY & CLEANING INSTRUCTIONS	4
SET UP	5
• ADDING/REMOVING THE ABDOMEN	5
• FITTING/REMOVING THE CERVIX	6
• SETTING UP THE DIFFERENT DRILLS	7
TRAINING	8
• NORMAL BIRTH	8
• BREECH BIRTH	9
• SHOULDER DYSTOCIA	10
CLEANING & STORAGE	11
• ADDING/REMOVING PERINEUM	11
• REPLACE/CLEAN IM PADS	11
• TIGHTEN/LOOSEN THE LEGS	11
AUGMENTED REALITY TRAINING (ART)	12
• SAFETY & CLEANING INSTRUCTIONS	12
• ART SET UP	13

TAKE A LOOK  
AT OUR **VIDEO**

VISIT THE WEBSITE  
[limbsandthings.com](https://limbsandthings.com)

OR YOUTUBE CHANNEL  
[youtube.com/limbsandthings](https://youtube.com/limbsandthings)



PACKAGE  
SUPPLIED

BIRTHING MOTHER

80120

80220

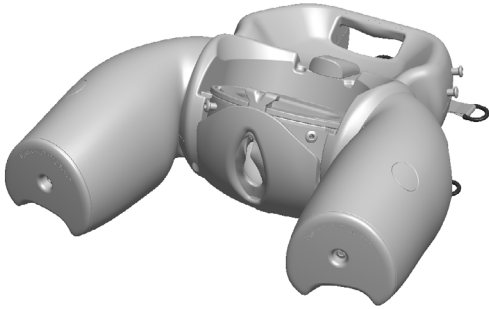

STANDARD BABY

80121

80221

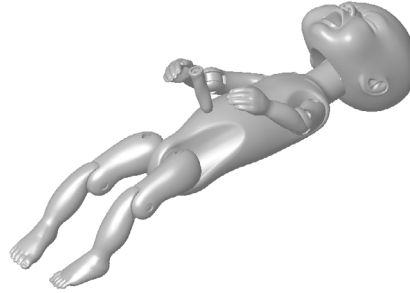

BIRTHING PLACENTA

80123

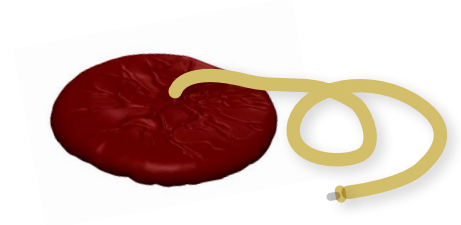

ABDOMEN

80124

80224



PERINEUM & BIRTH CANAL

80125

80225

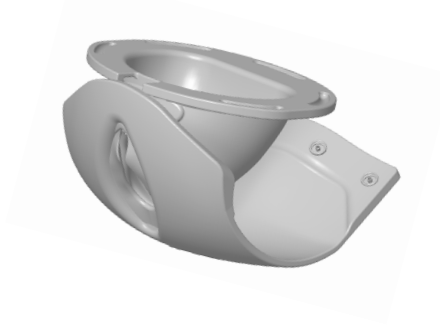

CERVIX

80126



PELVIC RING CLAMP

80107

80207



BED STRAPS

80130

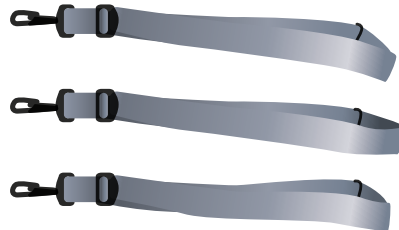

LUBRICANT

10193



WHEELED CARRY CASE

01000



PROMPT FLEX ART MAT

60133

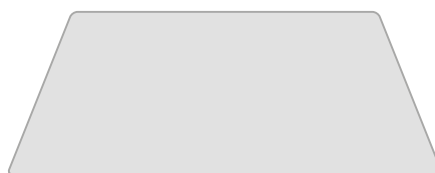

## SAFETY & CLEANING INSTRUCTIONS

READ THE SAFETY INSTRUCTIONS CAREFULLY BEFORE USING YOUR BIRTHING SIMULATOR PROMPT FLEX

### DO's



Follow all instructions. Keep these instructions. Heed all warnings.

Only use the lubricant and simulated blood supplied with this product. Use of non-recommended fluid products may weaken or damage the simulator.



Wear gloves at all times and remove all jewellery items. Sharp surfaces such as finger nails and rings can lead to damage of silicone parts.

Always lubricate the cervix, birth canal and baby before each birth.



Clean the product with a damp soft cloth or sponge, using only warm water with mild detergent, after every training session. Clean off excess lubricant from all mother and baby surfaces.

### STORAGE & TRANSPORTATION



Always ensure that the products are properly packed and secured during transportation and storage in order to prevent personal injury or damage to the product.

### DON'Ts



Do not install near any heat sources, do not expose the product to flames or use near naked flame sources. Do not use flammable solvents near or on this product.

Do not use any attachments other than those supplied by the manufacturer.



Do not wear any jewellery items.

Do not disassemble the product or attempt to repair a faulty unit, please return the product to Limbs & Things for assessment and repair.



A poorly lubricated baby or placenta may damage the birth canal or the cervix as it is pushed through.

## SET UP

### ADDING/REMOVING THE ABDOMINAL SKIN

The abdomen can be added/removed easily to facilitate correct positioning of the baby within the pelvis if necessary.

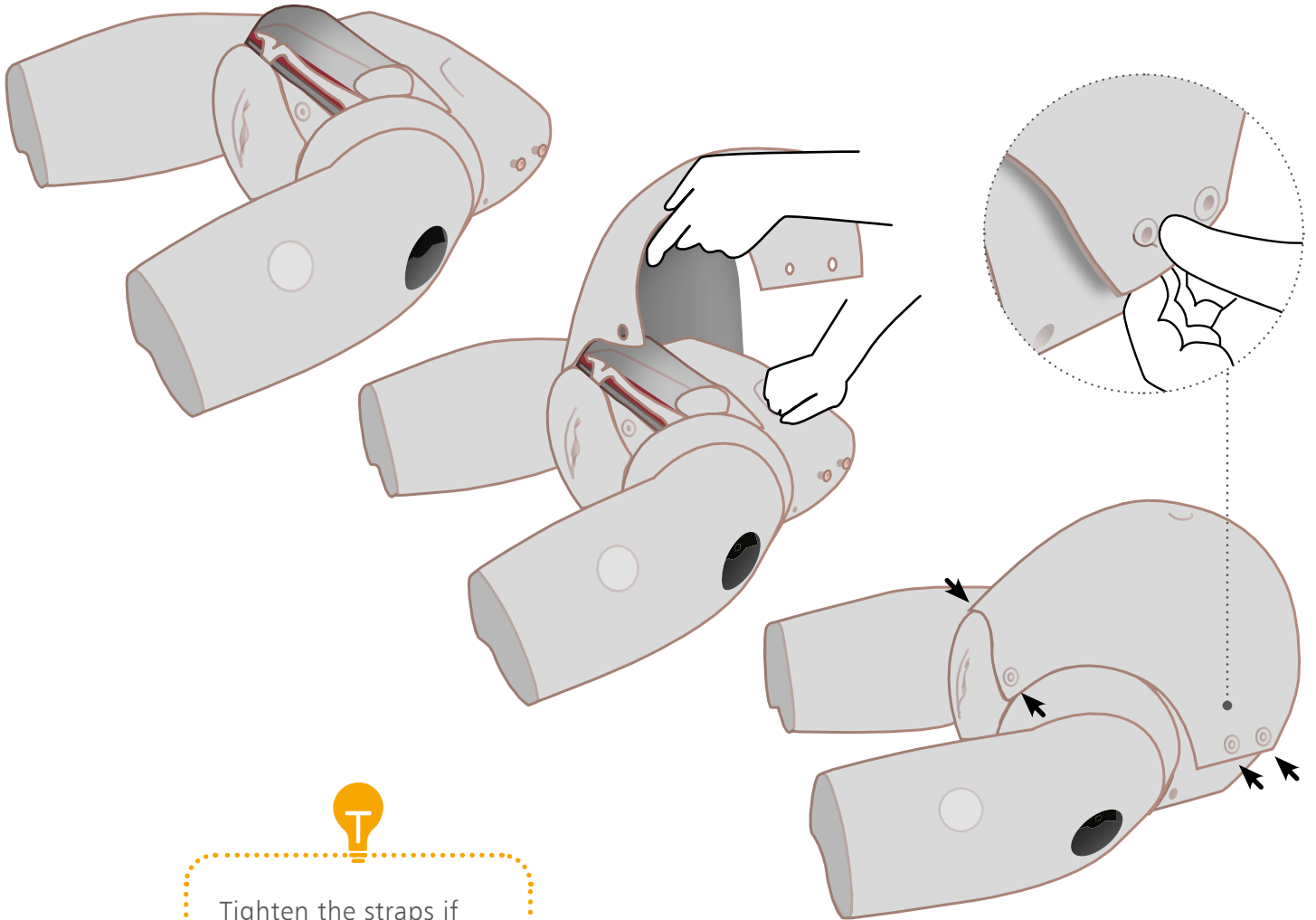

Tighten the straps if necessary to secure the model to the table top.

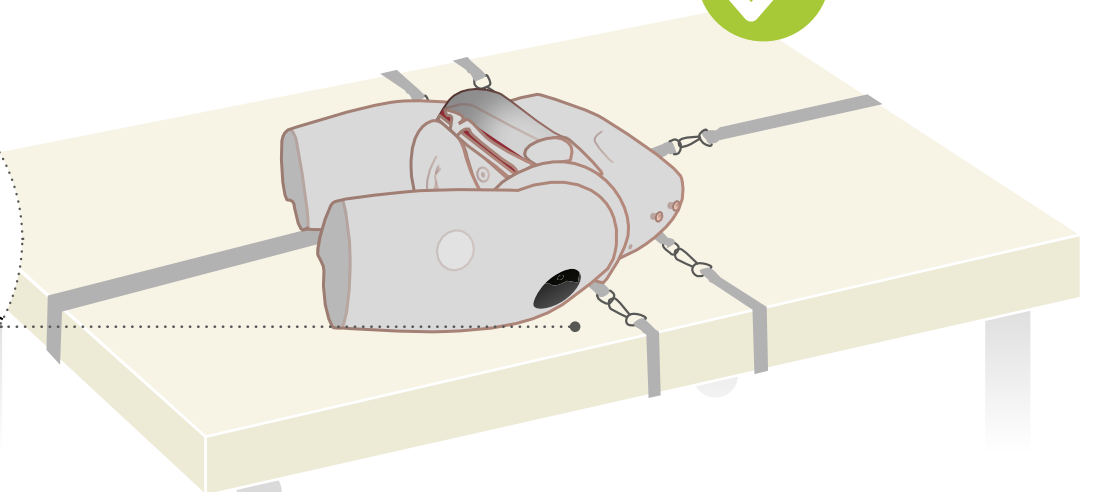
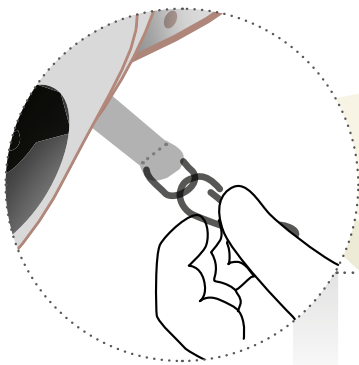

SET UP

REMOVING THE CERVIX

DRILLS	CERVIX REQUIRED
Normal Birth	✓
Breech Birth	✗
O.V.D.	✗
Shoulder Dystocia	✗

1

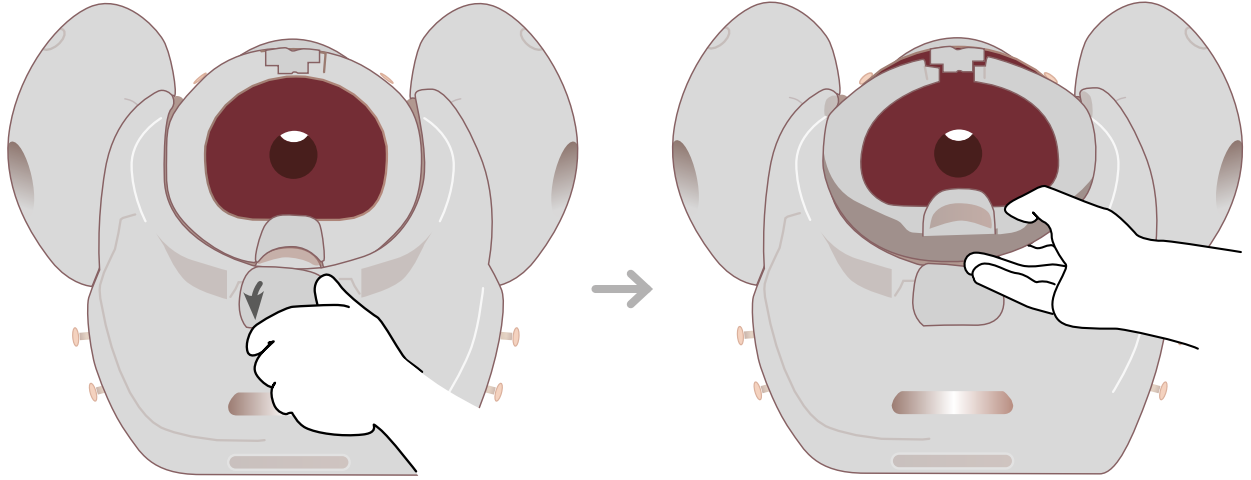

2

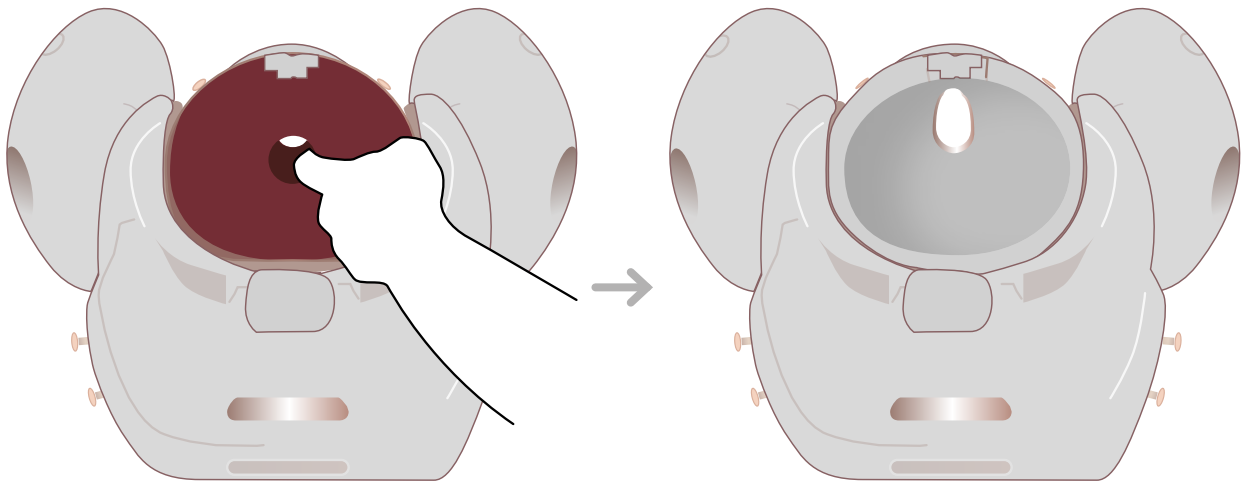

3

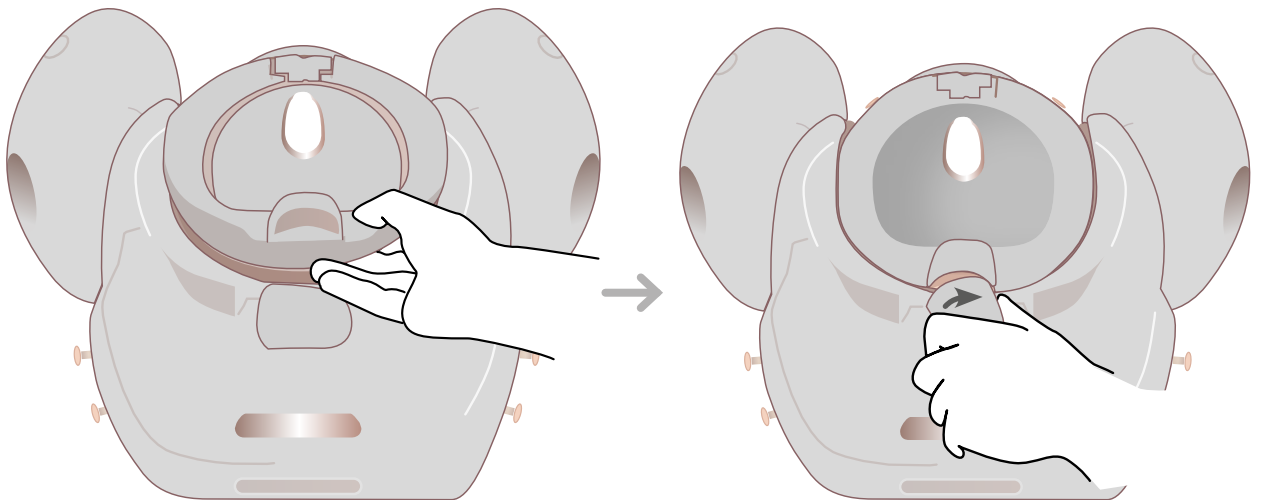

# SET UP

## SETTING UP THE DIFFERENT DRILLS

Always lubricate before each birth.

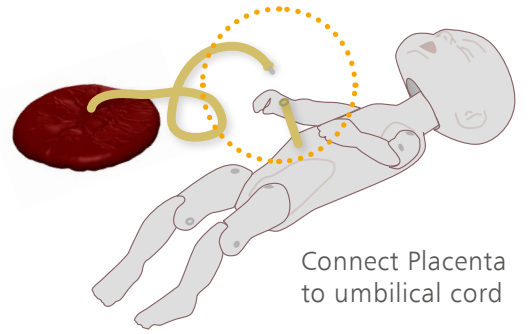

### NORMAL BIRTH

### EXTENDED BREECH BIRTH

### SHOULDER DYSTOCIA

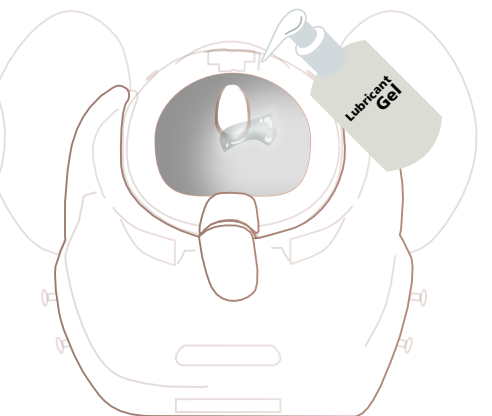
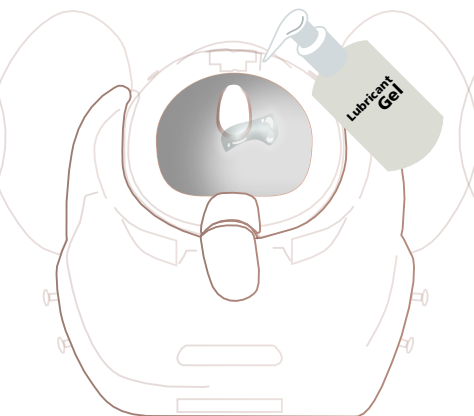
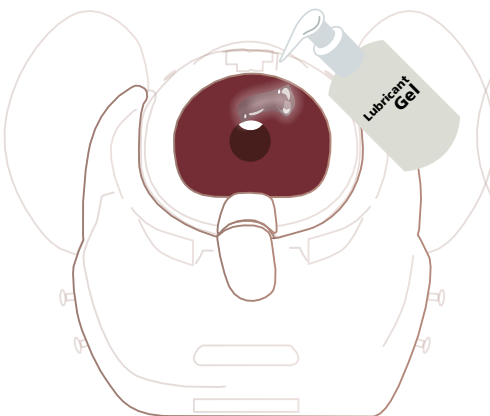
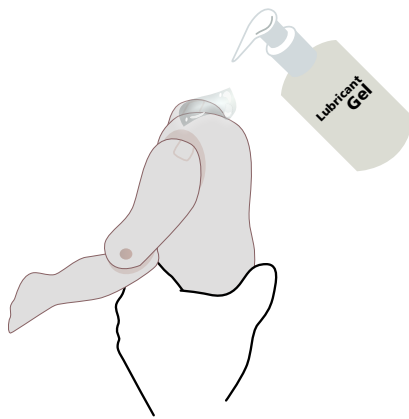
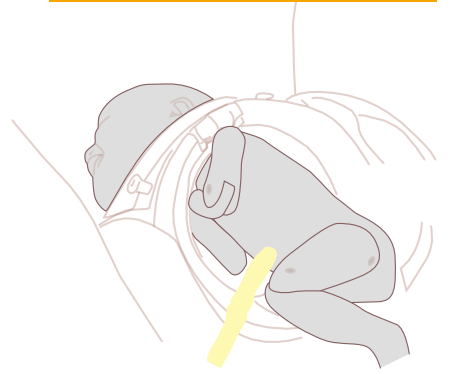
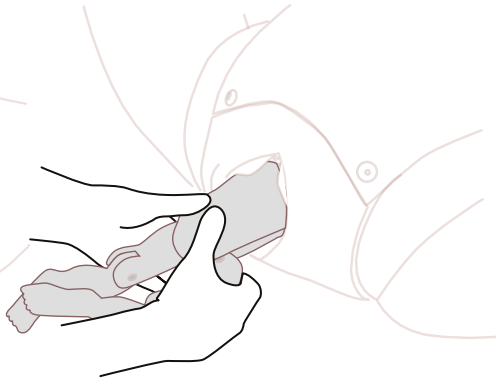
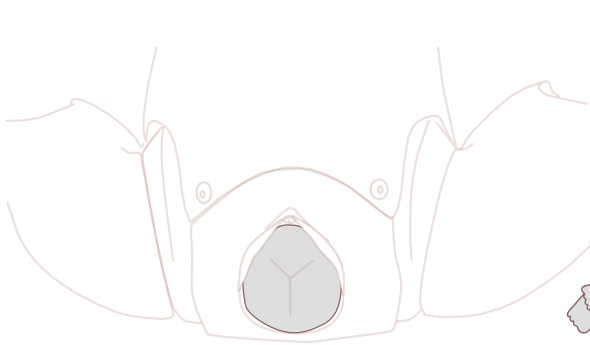

# TRAINING

## NORMAL BIRTH

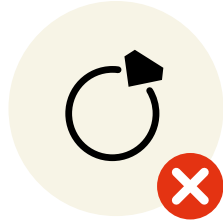

Push the baby through the pelvis, rotating the baby as appropriate to mimic the mechanism of normal delivery.

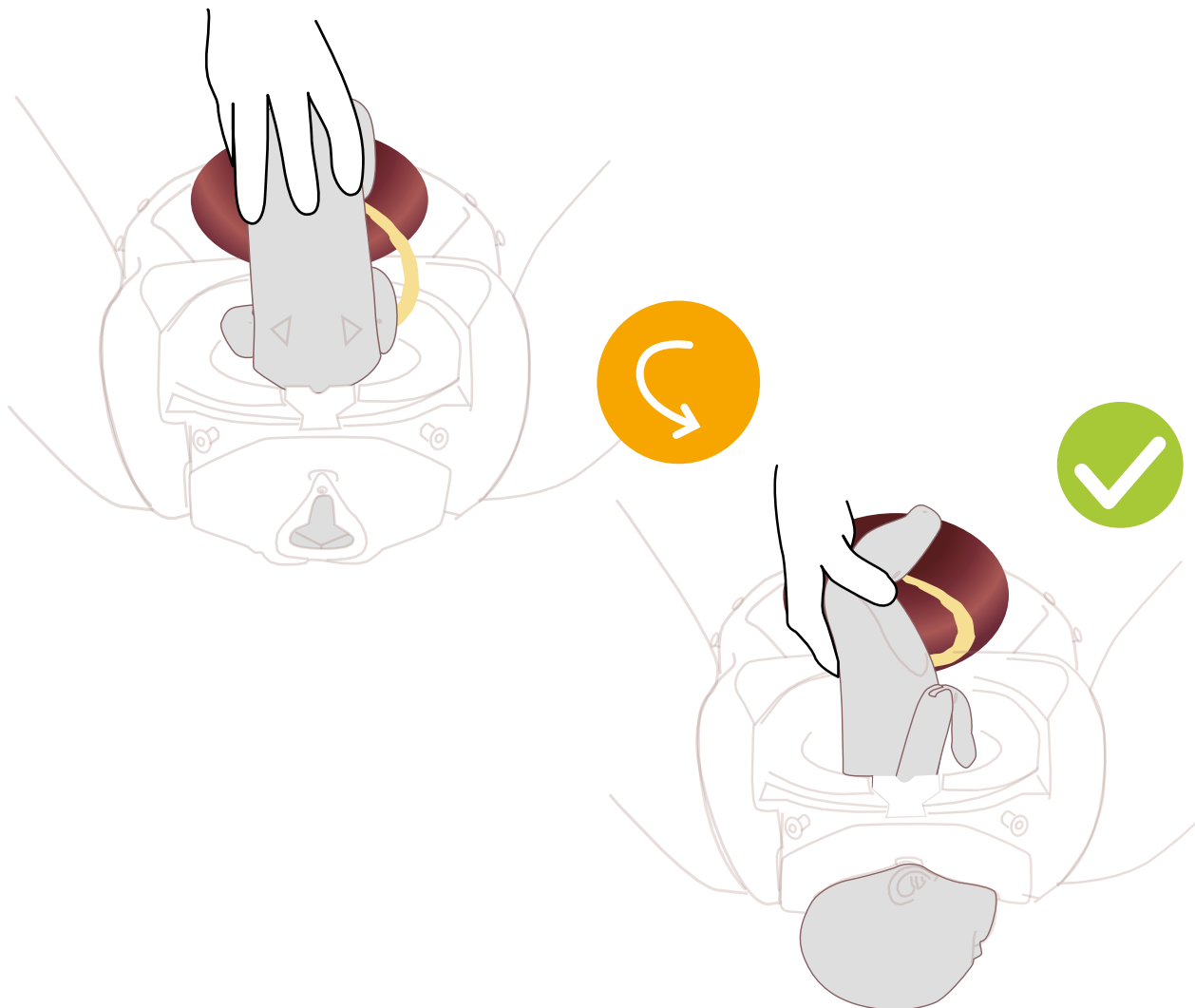



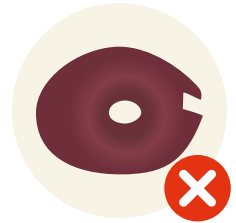
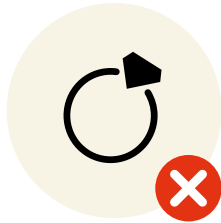

Push on the head to simulate contractions and maternal effort. Ensure the baby's arms remain flexed during the delivery.

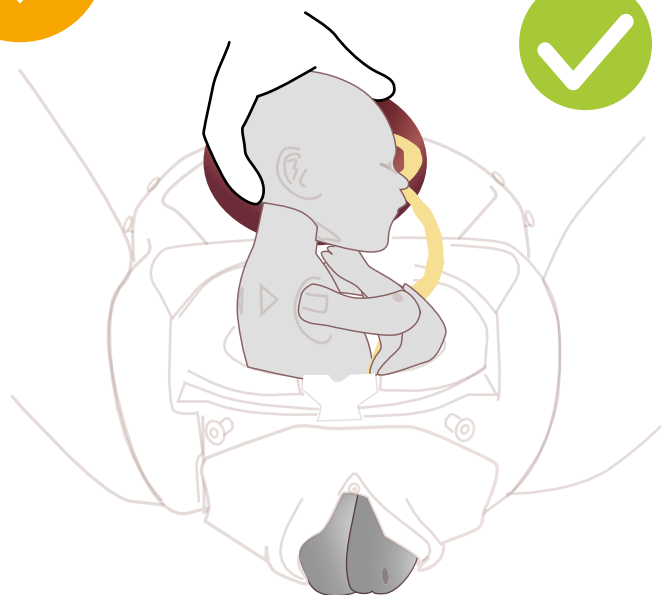
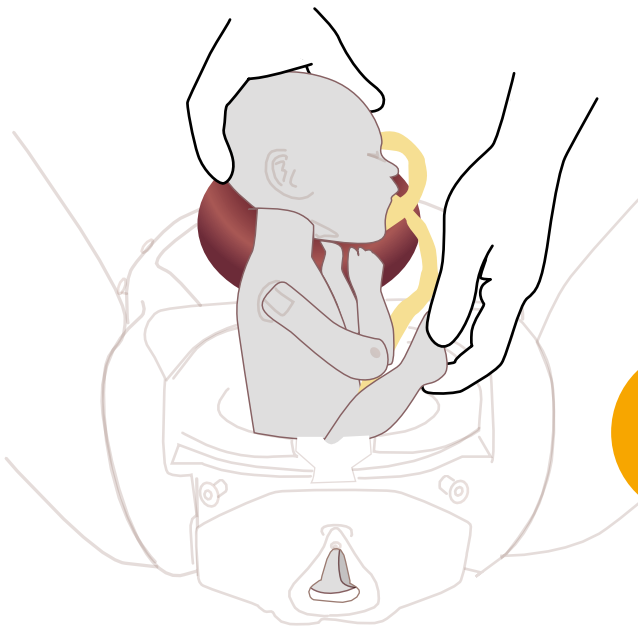

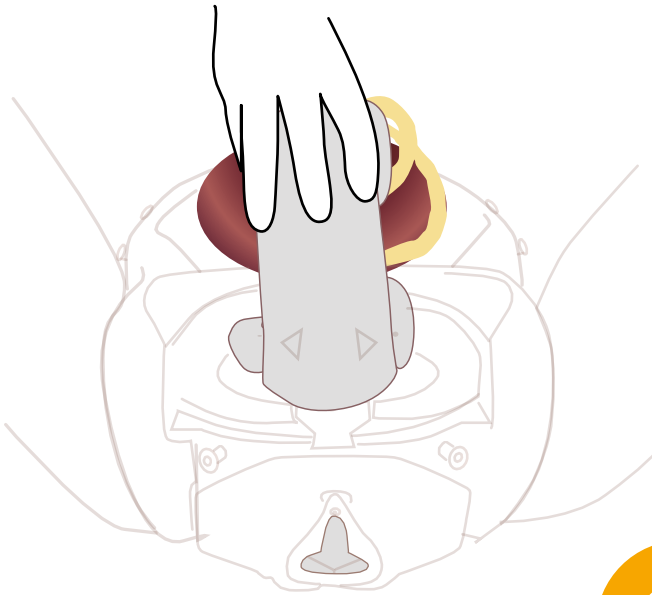
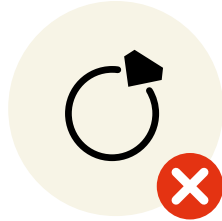

! Ensure that the anterior shoulder of the baby is wedged behind the symphysis pubis.

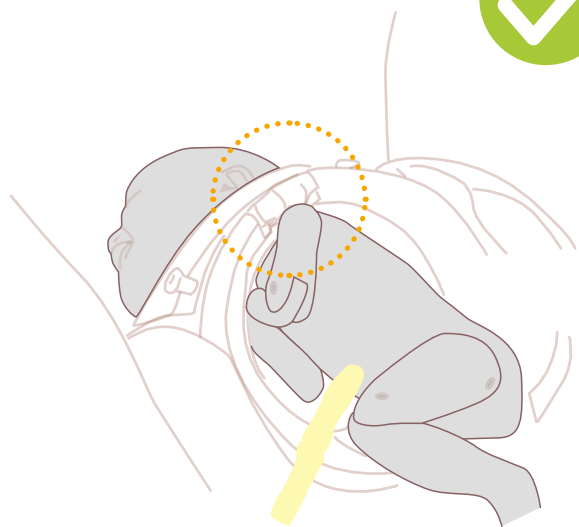
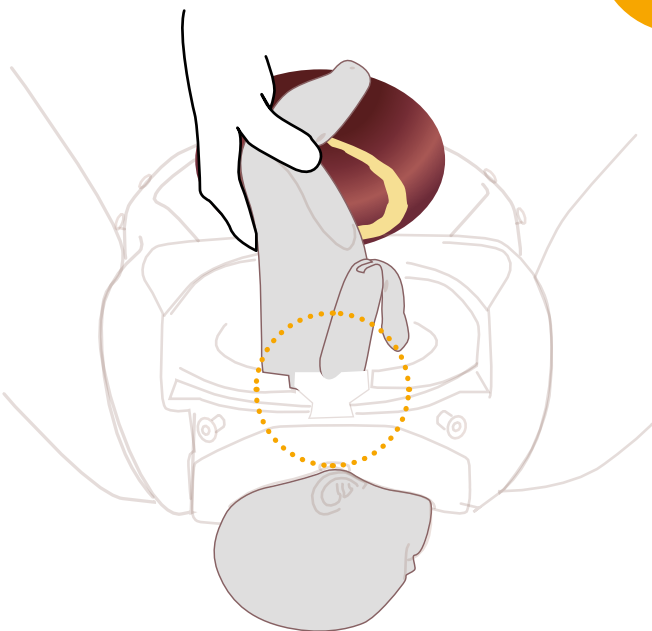

## CLEANING & STORAGE

### ADDING/REMOVING PERINEUM

After each training session, clean all the lubrication from all mother and baby surfaces with a warm damp cloth.

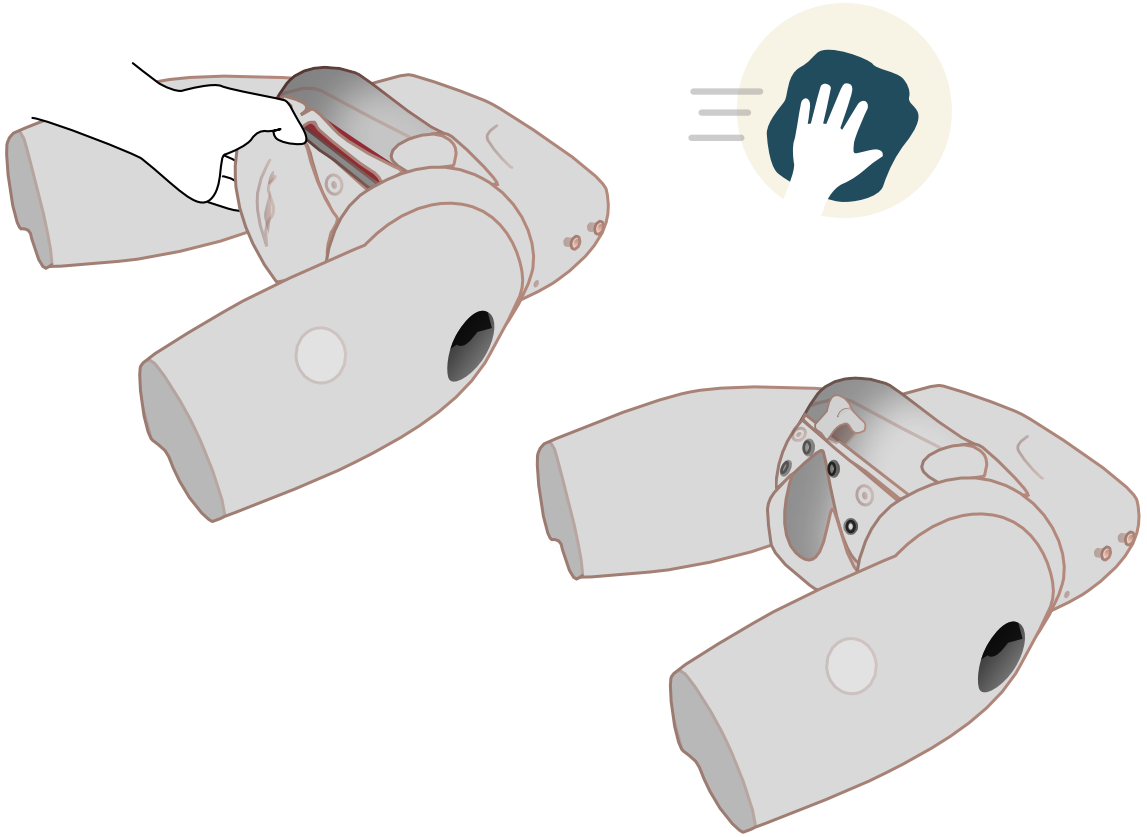

### REPLACE/CLEAN IM PADS

### TIGHTEN/LOOSEN THE LEGS

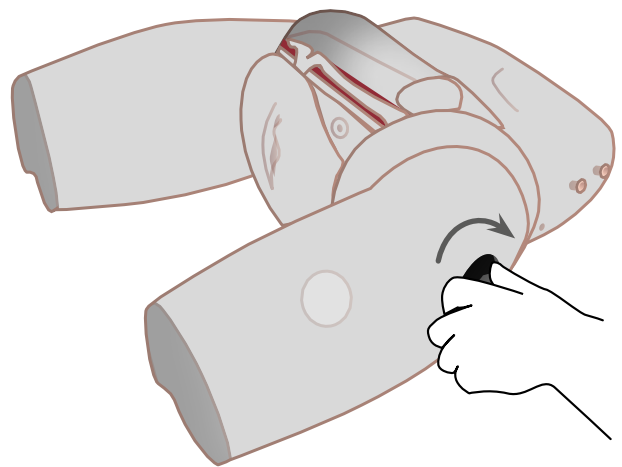
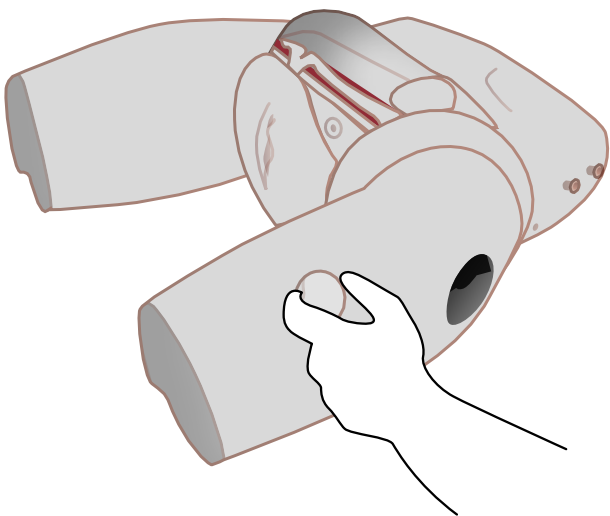



# AUGMENTED REALITY TRAINING (ART)

for your PROMPT Flex Birthing Simulator

# SAFETY & CLEANING INSTRUCTIONS

Read the safety instructions carefully before using your ART Mat

## DO's



Follow all instructions. Keep these instructions. Heed all warnings

Use mat on flat surface

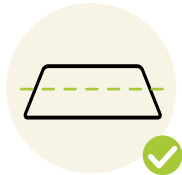

Only use attachments/accessories specified by Limbs & Things

Refer all servicing to qualified service personnel. Servicing is required when the apparatus has been damaged



## DON'Ts



Do not install near any heat sources, do not expose the product to flames or use near naked flame sources. Do not use flammable solvents near or on this product

Do not set up the product near electrical appliances or items damaged by water



Do not cover the graphic of the mat with other items

Do not move the mat with a model on top of it



## STORAGE



Store rolled up with print on the outside



Don't fold

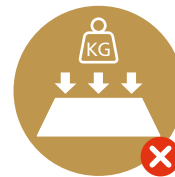

Don't place heavy objects on top

## CLEANING



Can be cleaned with water, soap and non-alcoholic cleaning agents



Avoid abrasive and alcoholic cleaning agents



Make sure mat is dry before storing

## ART SET UP

1

Take the mat out of tube

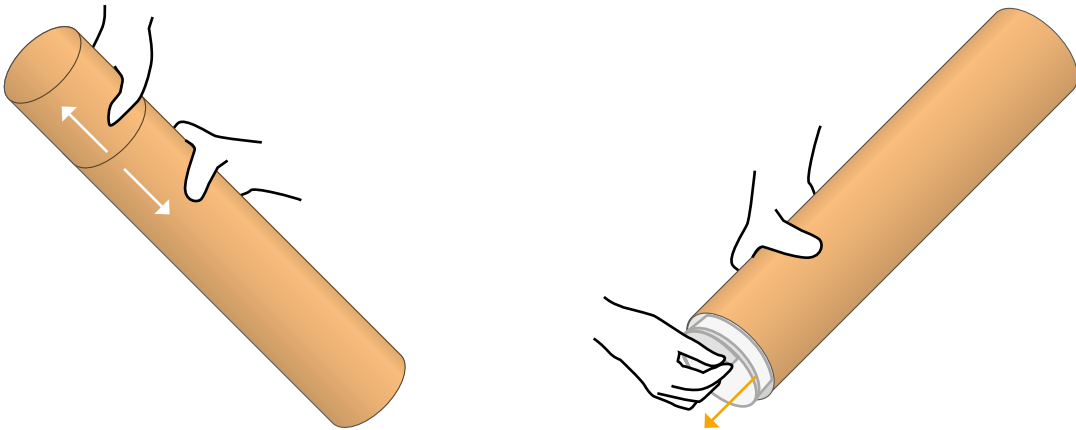

2

Place the mat on a table

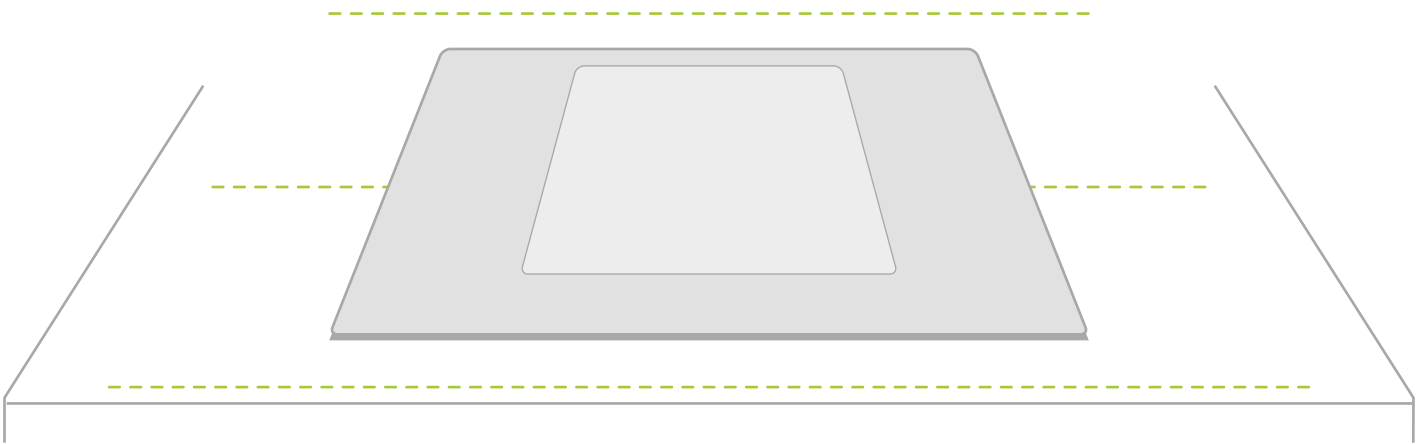

Note: Diagrams are for illustrative purposes, your product may differ from the example shown

3

Place the the model on the designated area of the mat

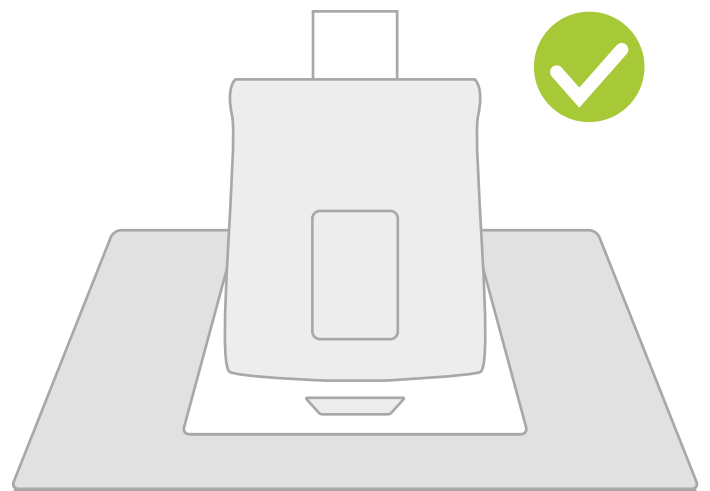
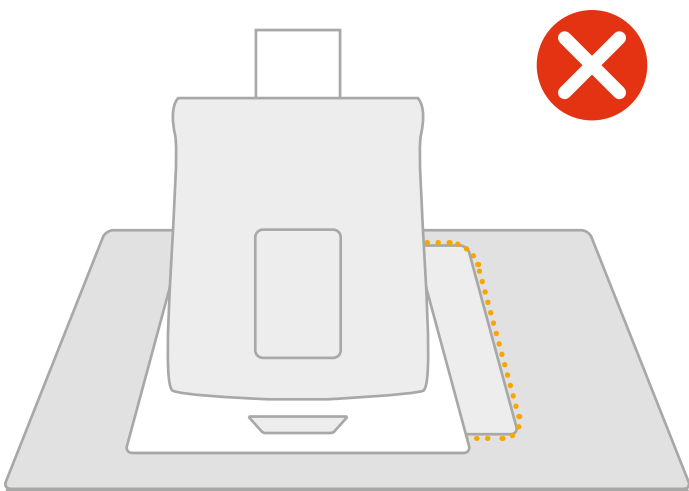
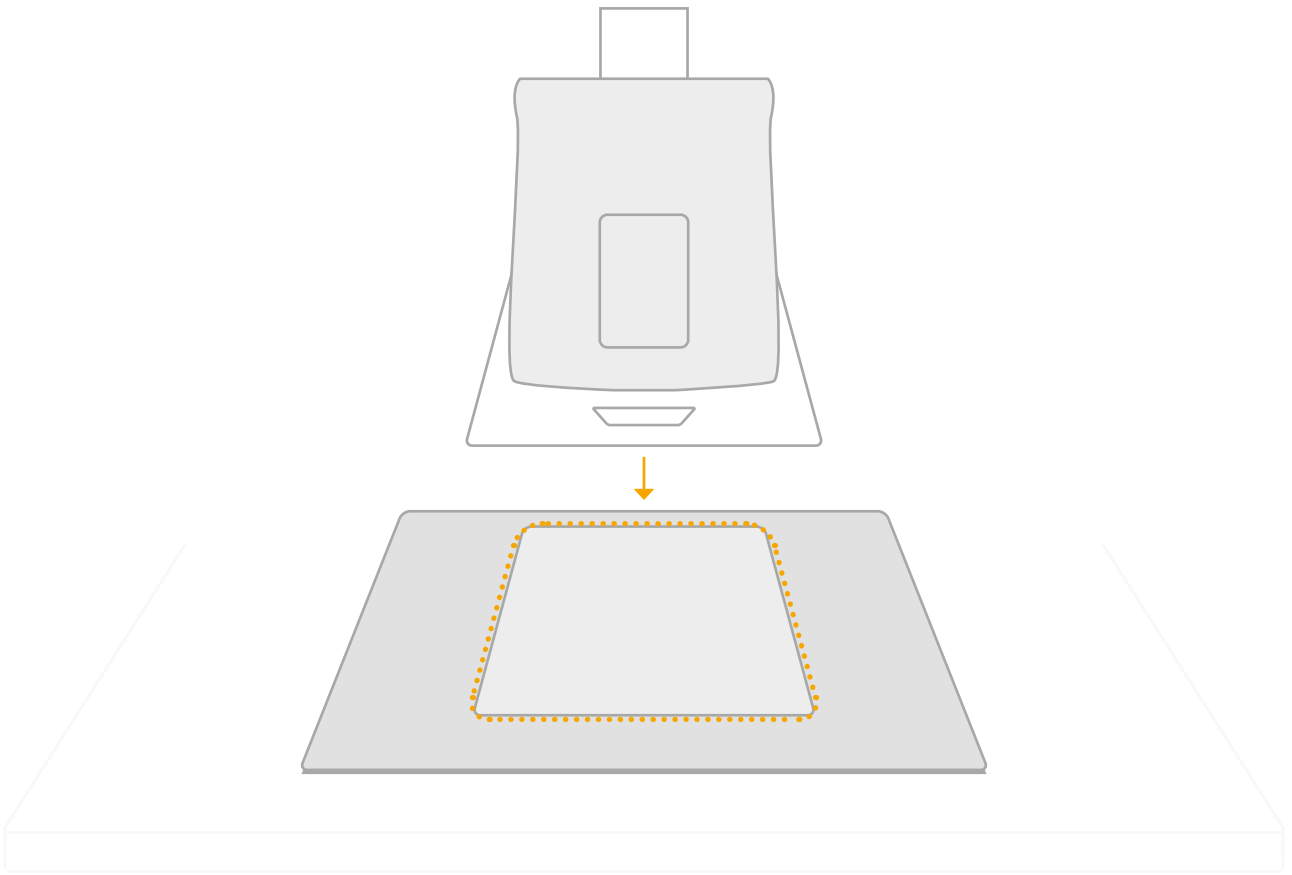

Note: Diagrams are for illustrative purposes, your product may differ from the example shown

Use the A.R.T. app to scan the mat

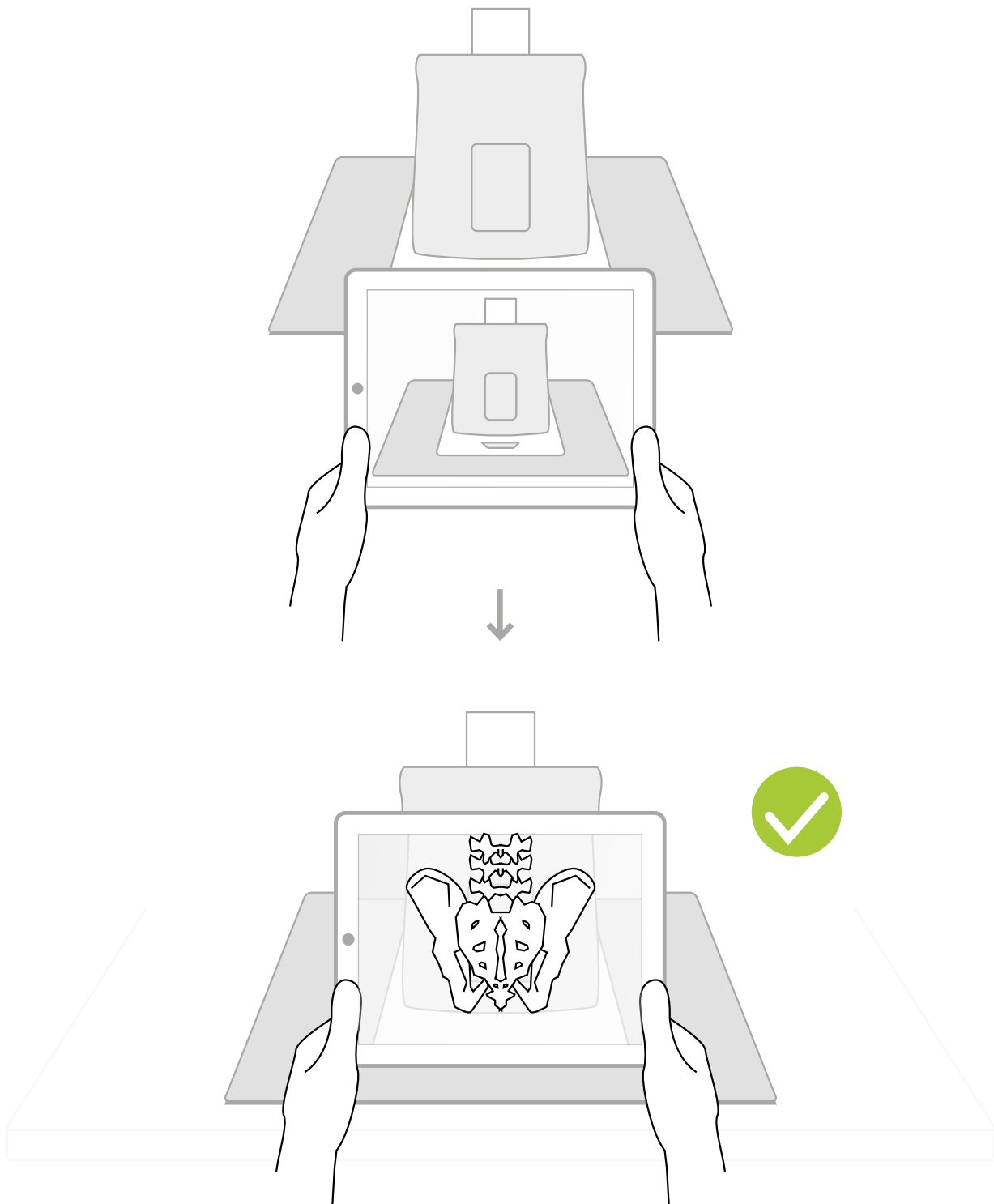

For app troubleshooting please visit the website.

Note: Diagrams are for illustrative purposes, your product may differ from the example shown

ADDITIONAL MODULES  
ALLOW YOU TO TAILOR  
YOUR TRAINING NEEDS

LOWER LEGS -  
PROMPT FLEX



CERVICAL  
DILATATION  
& EFFACEMENT

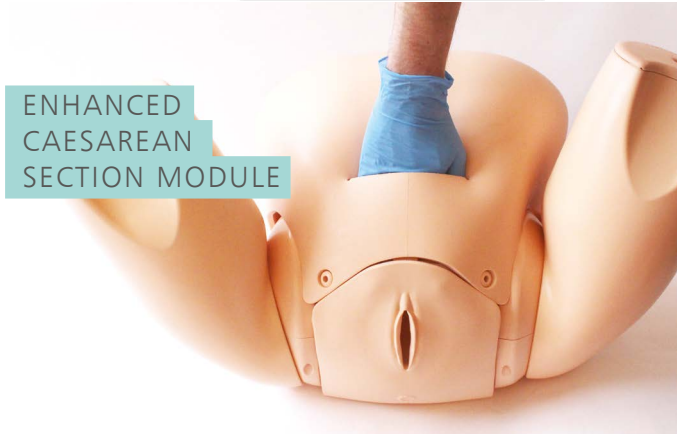

ENHANCED  
CAESAREAN  
SECTION MODULE

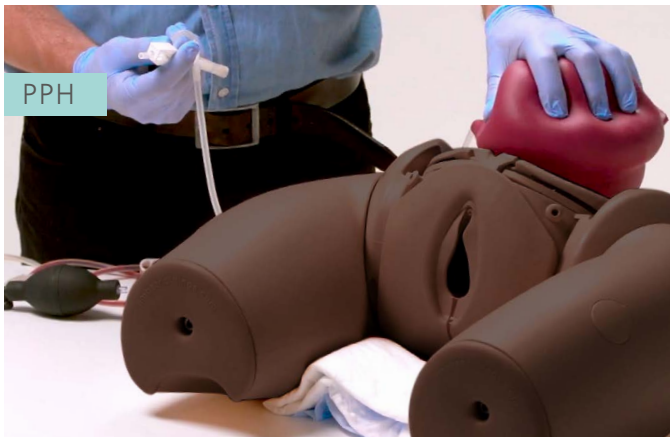

PPH

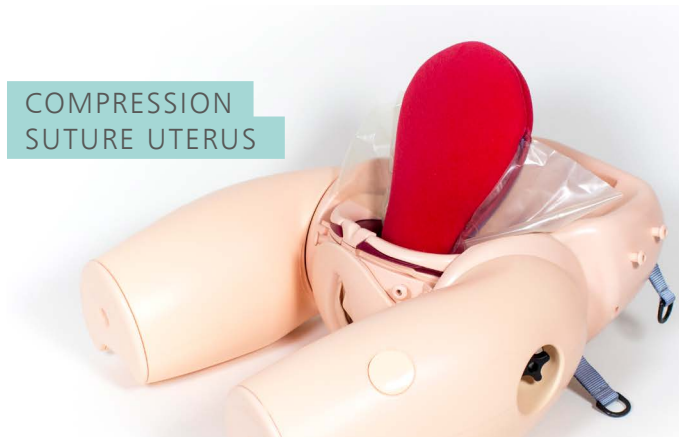

COMPRESSION  
SUTURE UTERUS

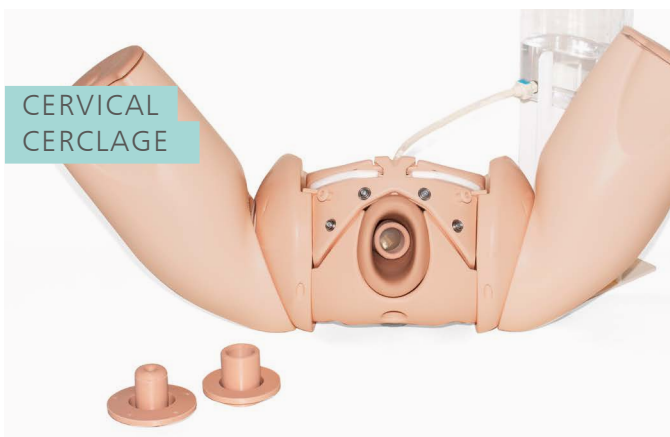

CERVICAL  
CERCLAGE