



USER GUIDE

CHEST DRAIN & NEEDLE DECOMPRESSION TRAINER

This product is available
in light and dark skin tones

60230

61230

FOR MORE SKILLS TRAINING PRODUCTS VISIT

limbsandthings.com

Sussex Street, St Philips, Bristol, BS2 0RA, UK | sales@limbsandthings.com | +44 (0) 117 311 0500

INDEX

PACKAGE SUPPLIED	3
SAFETY & CLEANING INSTRUCTIONS	4
PAD USAGE INFORMATION	5
SET UP	6
• REMOVING THE TORSO SKIN	6
• INSERTING THE RIBS INTO A PAD	7
• FITTING A PAD	8
• REMOVING THE NEEDLE DECOMPRESSION PADS	10
• FITTING THE NEEDLE DECOMPRESSION PADS	11
• FILLING THE CHEST RESERVOIRS	12
• USING THE NEEDLE DECOMPRESSION PUMP	13
• USING THE RESPIRATORY SWING PUMP	14
CLEANING & STORAGE	15
• EMPTYING THE CHEST RESERVOIRS	15
• REMOVING/FITTING THE LUNG & DIAPHRAGM	15
AUGMENTED REALITY TRAINING (ART)	16
• SAFETY & CLEANING INSTRUCTIONS	16
• ART SET UP	17

TAKE A LOOK AT OUR **VIDEO**

VISIT THE WEBSITE
limbsandthings.com

OR YOUTUBE CHANNEL
youtube.com/limbsandthings



PACKAGE
SUPPLIED

Torso

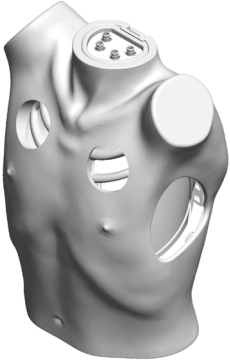

Needle Decompression
Pads (x2)

60231 61231

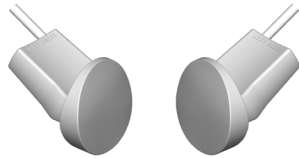

Advanced Chest Drain
Pads (x2)

60232 61232

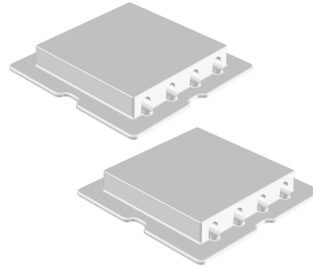

Standard Chest Drain
Pads (x2)

60234 61234

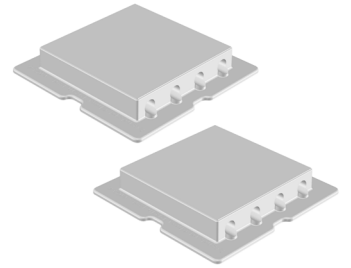

Chest Drain Rib Frame
(Left)

60235



Chest Drain Rib Frame
(Right)

60237



Chest Drain
Lungs (x2)

60238



Chest Drain
Diaphragms (x2)

60239



Chest Drain Ribs (x12)

60240



Water-Based Lubricant

00293



Chest Drain Pump:
Respiratory Swing

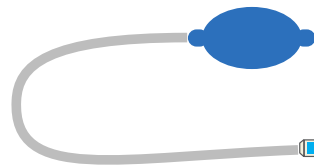

Chest Drain Pump:
Needle Decompression

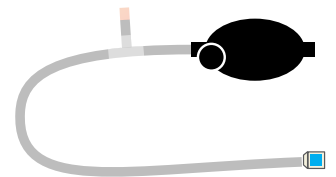

Chest Drain Slotted
Retaining Knobs (x12)

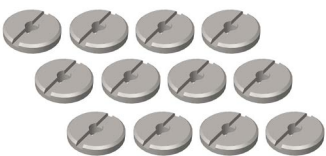

Key
with keyring

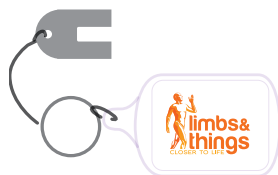

Carry
Case



ART mat

60132

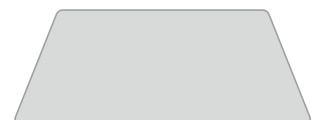

SAFETY & CLEANING INSTRUCTIONS

READ THE SAFETY INSTRUCTIONS CAREFULLY BEFORE USING YOUR CHEST DRAIN & NEEDLE DECOMPRESSION TRAINER

DO's



Follow all instructions.
Keep these instructions.
Heed all warnings.

Only use attachments/accessories specified by Limbs & Things



If a product is damaged or worn, it should be repaired by Limbs & Things. To arrange this, please contact your point of purchase who will be able to provide a repair quote.

Clean the product with a damp soft cloth or sponge, using only warm water with mild detergent. The product must be stored dry.



DON'Ts



Do not install near any heat sources, do not expose the product to flames or use near naked flame sources. Do not use flammable solvents near or on this product.

Never use the product outdoors as this may damage the product.



Do not disassemble the product or attempt to repair a faulty unit, please return the product to Limbs & Things for assessment and repair.

Do not allow young children to use this product.



STORAGE & TRANSPORTATION



The trainer and its accessories are heavy when packed in the carrying case.



Always ensure that the products are properly packed and secured during transportation and storage in order to prevent personal injury or damage to the product.

PAD USAGE INFORMATION

ADVANCED CHEST DRAIN PADS

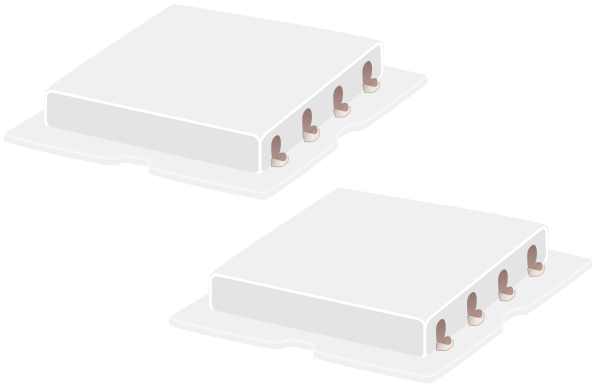

- Ultrasoundable
- For use with liquids – e.g. effusion, or haemothorax
- Needle, guide wire, dilator, and drain-tube can all be realistically inserted
- For open/surgical techniques where effusion or haemothorax are required
- Can be sutured
- Guidewire insertions will self-seal allowing multiple uses
- Open/surgical incisions will not self-seal
- Improved respiratory swing
- Recommend usage of 12 FG catheter



STANDARD CHEST DRAIN PADS

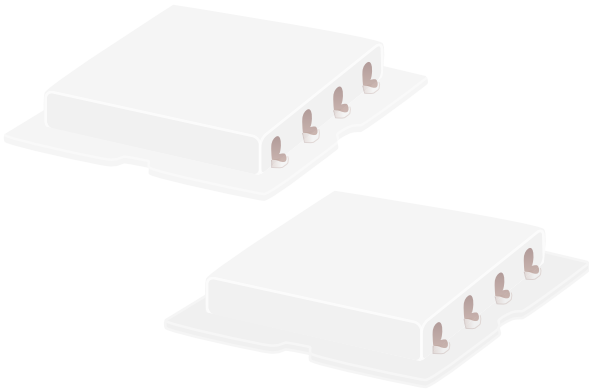

- For open/surgical techniques
- Can also be used for guide wire techniques where no fluid is required
- Not ultrasoundable
- Not suitable for use with liquids
- Tough skin for incision and suturing
- Foam chest wall for blunt dissection
- Pleural layer, providing realistic give, or “pop”, on puncture
- Can be used with adhesive dressings

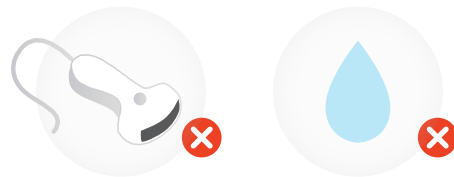

NEEDLE DECOMPRESSION PADS

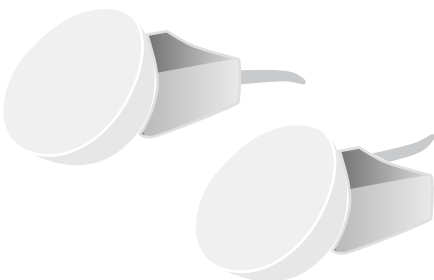

- Needle insertion produces realistic “hiss” of air escape, or bubbles if saline-filled syringe is used
- For optimum performance ensure pad is inflated just before use
- Pad life prolonged by use of thinner gauge needles eg 21g

SET UP

REMOVING THE TORSO SKIN

1

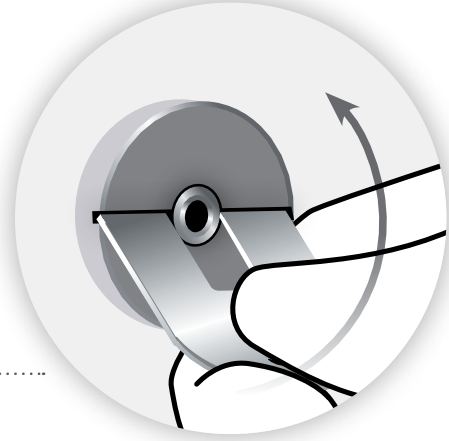
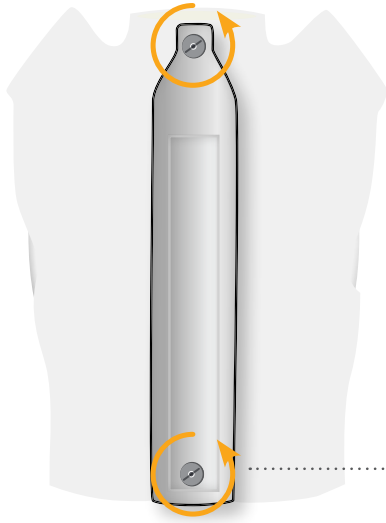

2

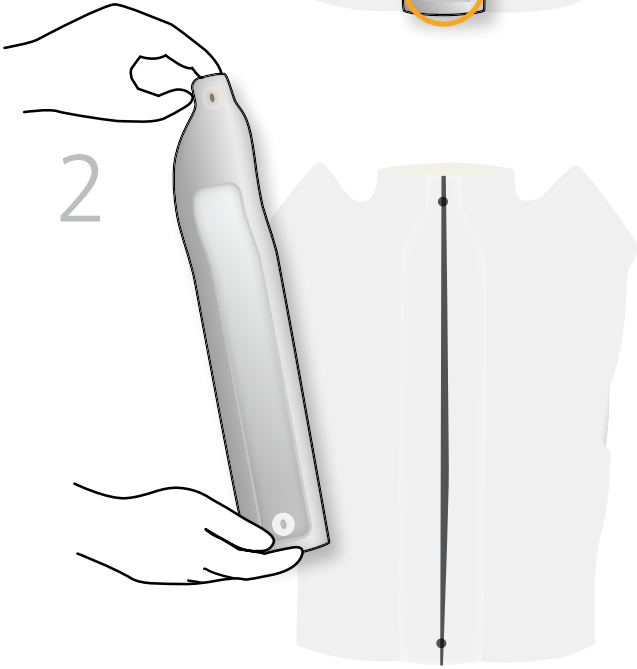

3

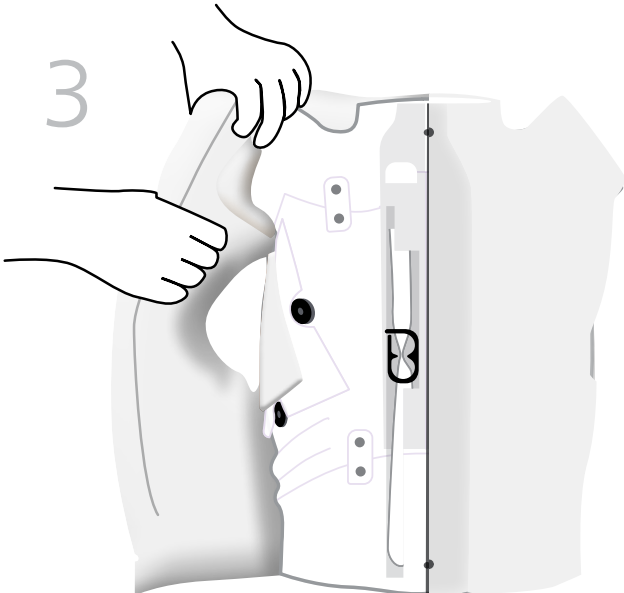

INSERTING THE RIBS INTO A PAD

1

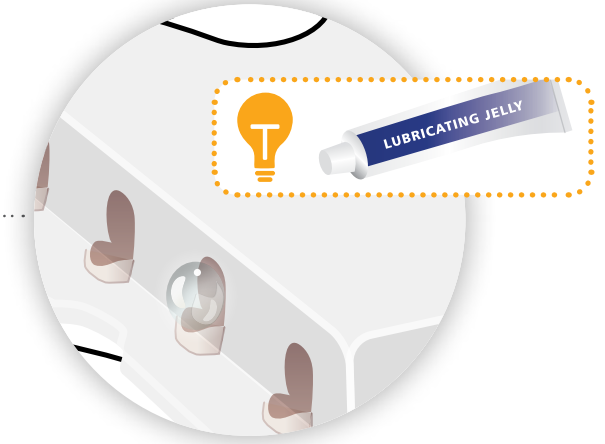
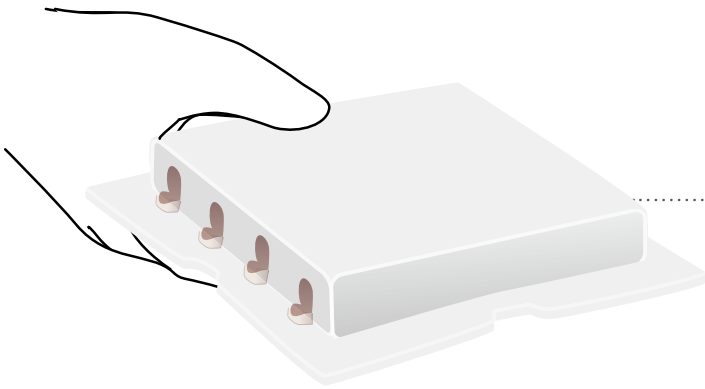

2

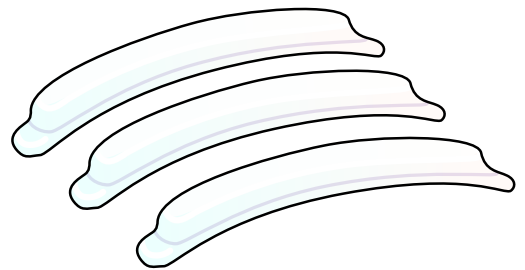
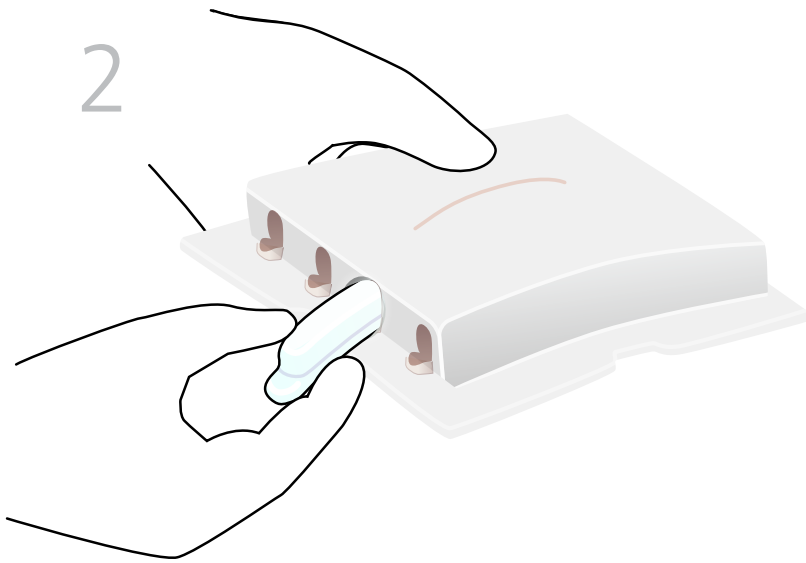

3

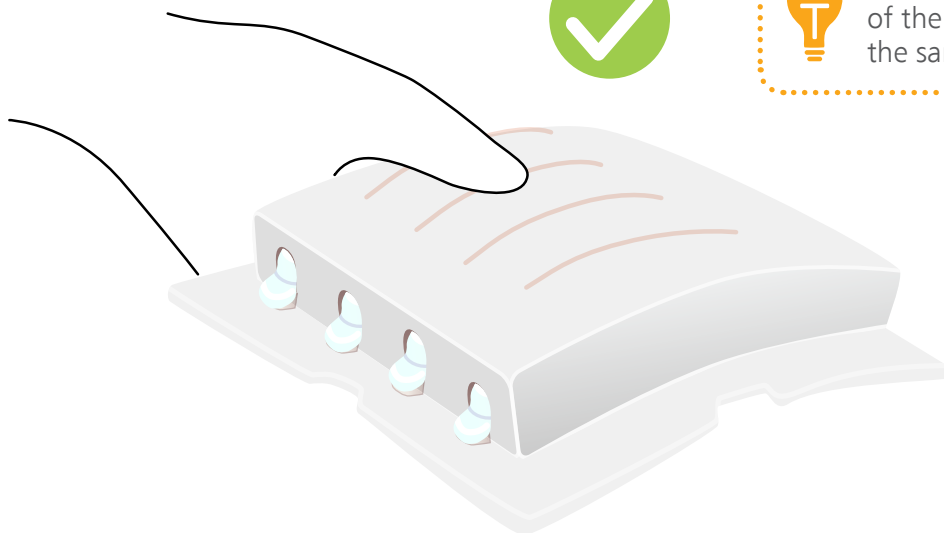

Make sure that all of the ribs curve in the same direction

FITTING A PAD

1

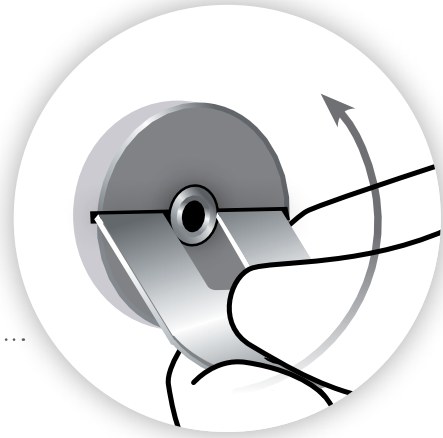
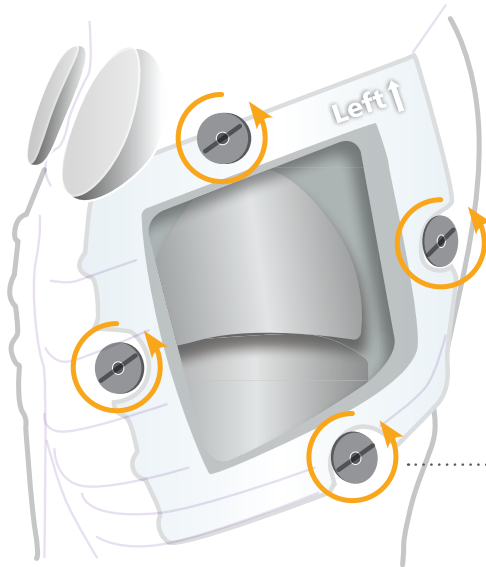

2

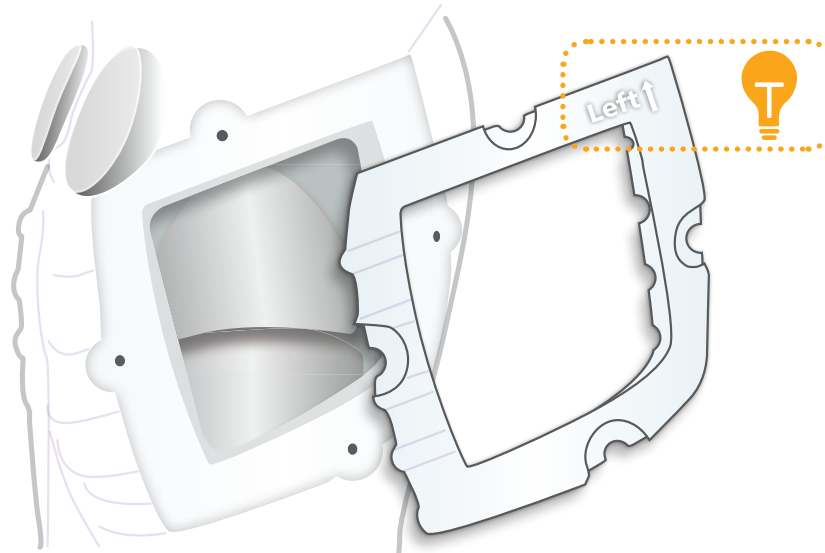

3



4

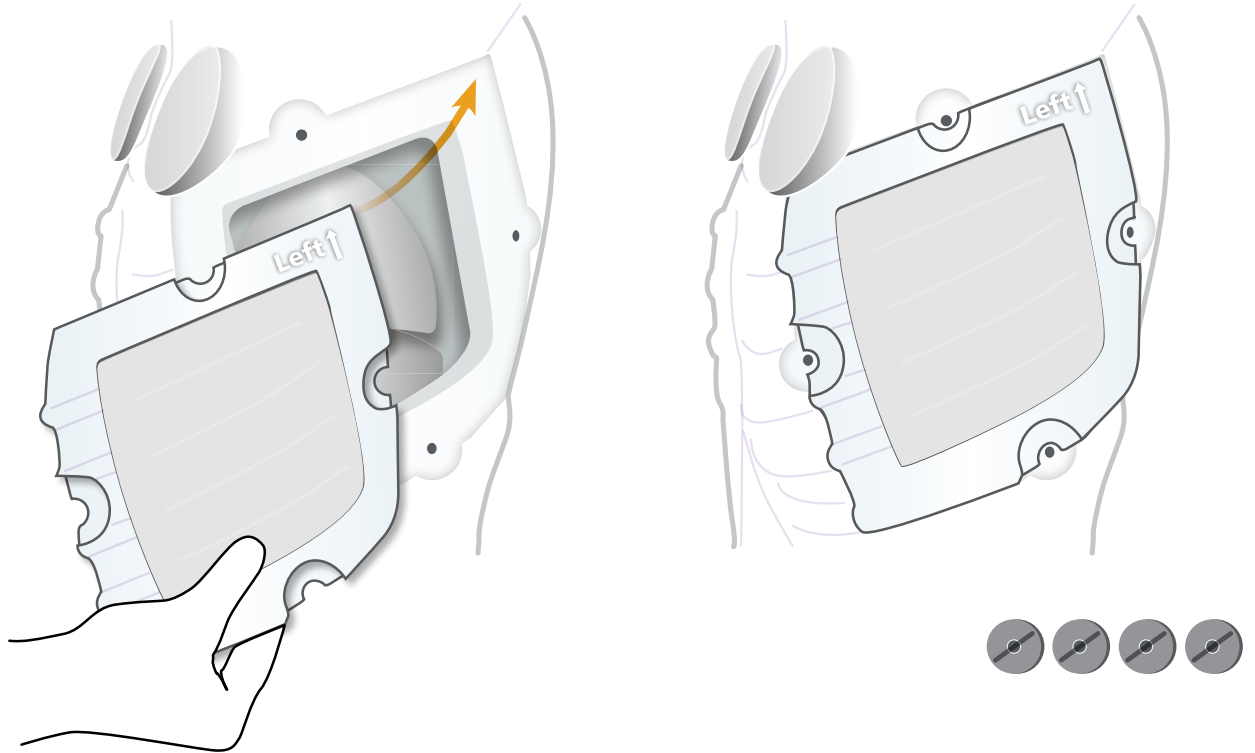

5

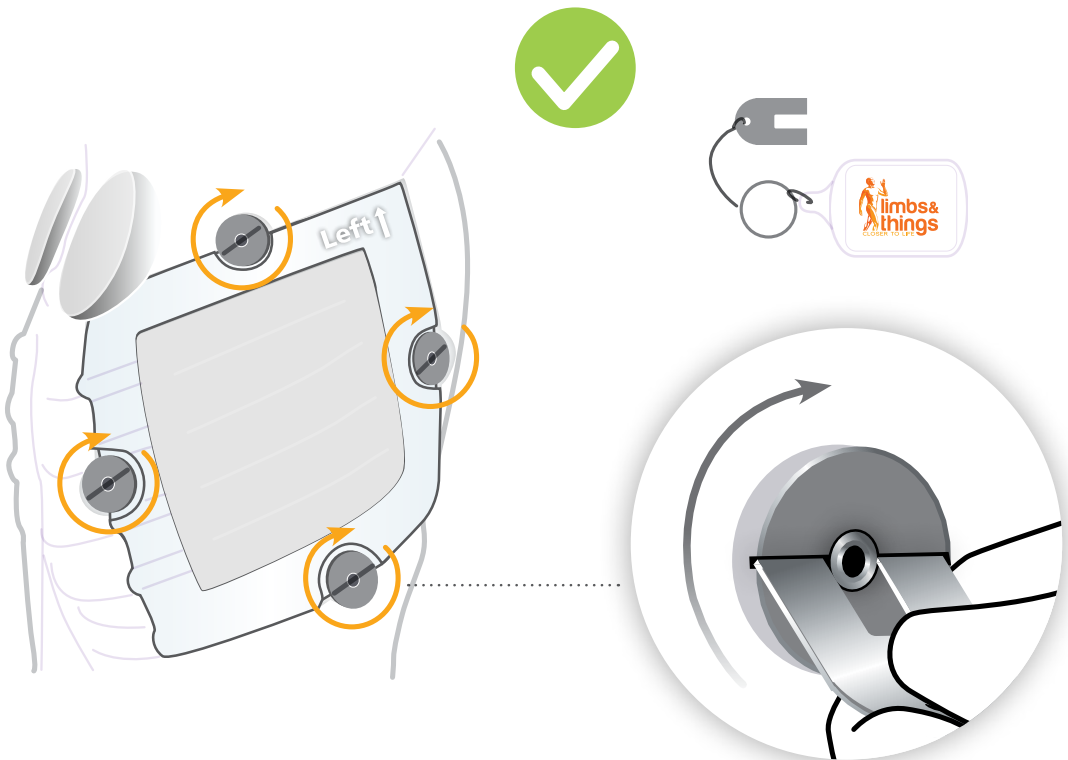

REMOVING THE NEEDLE DECOMPRESSION PADS

1

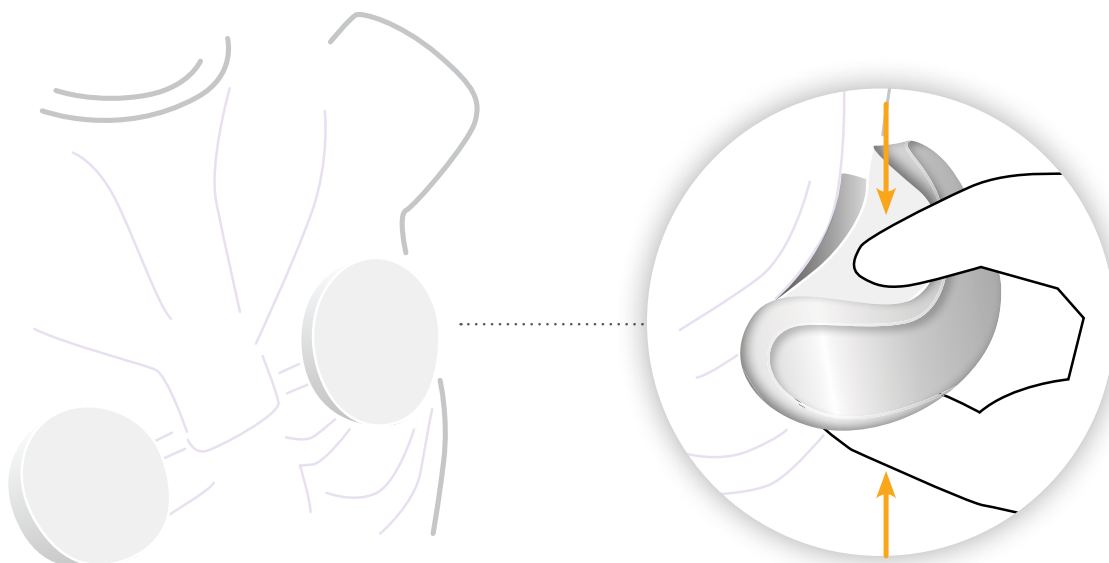

2

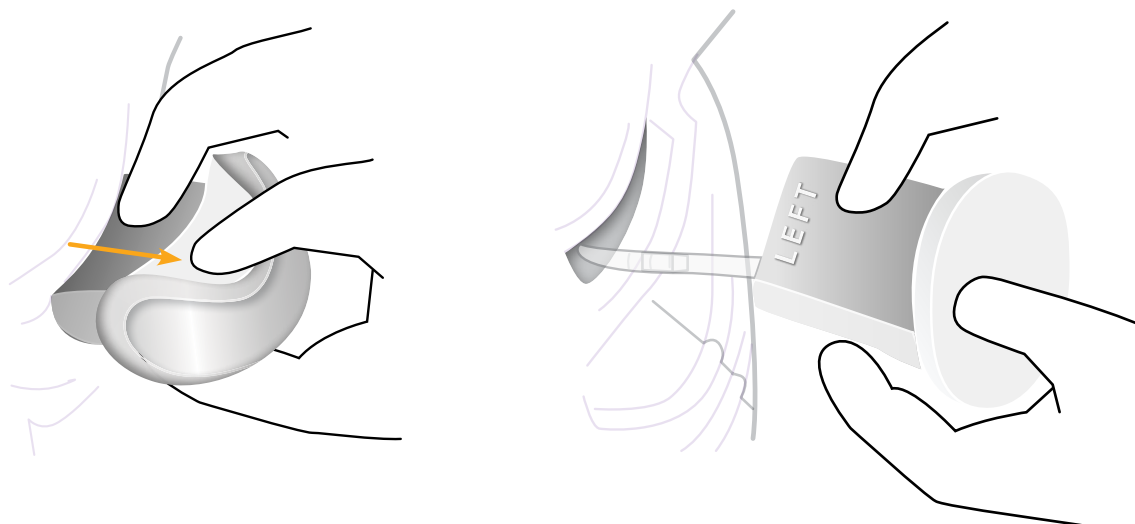

3

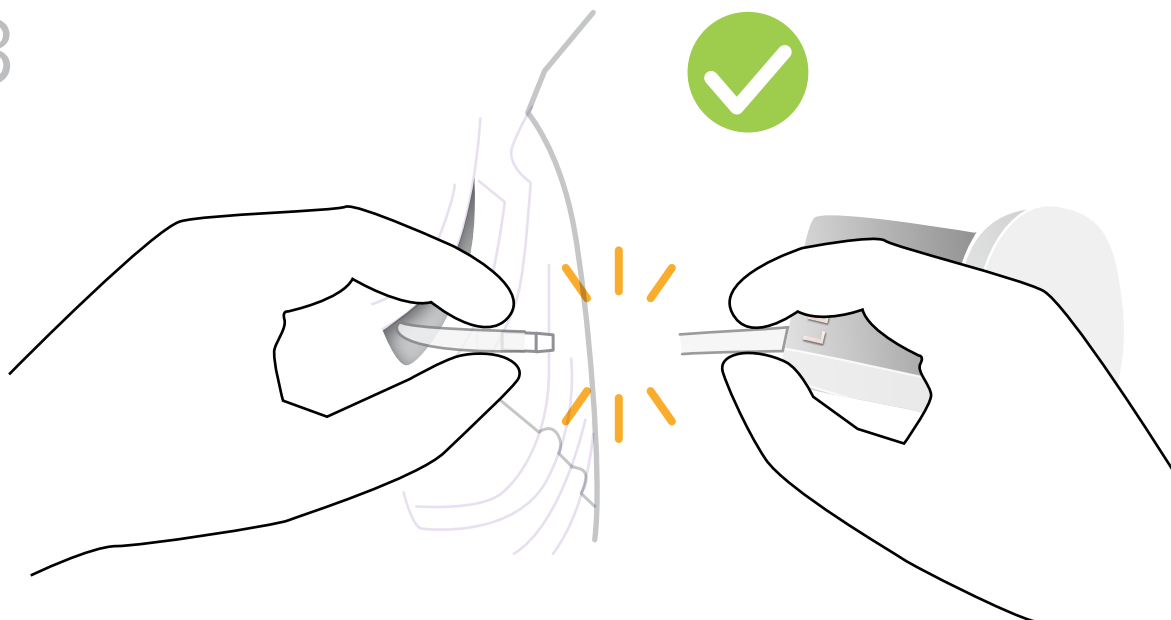

FITTING THE NEEDLE DECOMPRESSION PADS

1

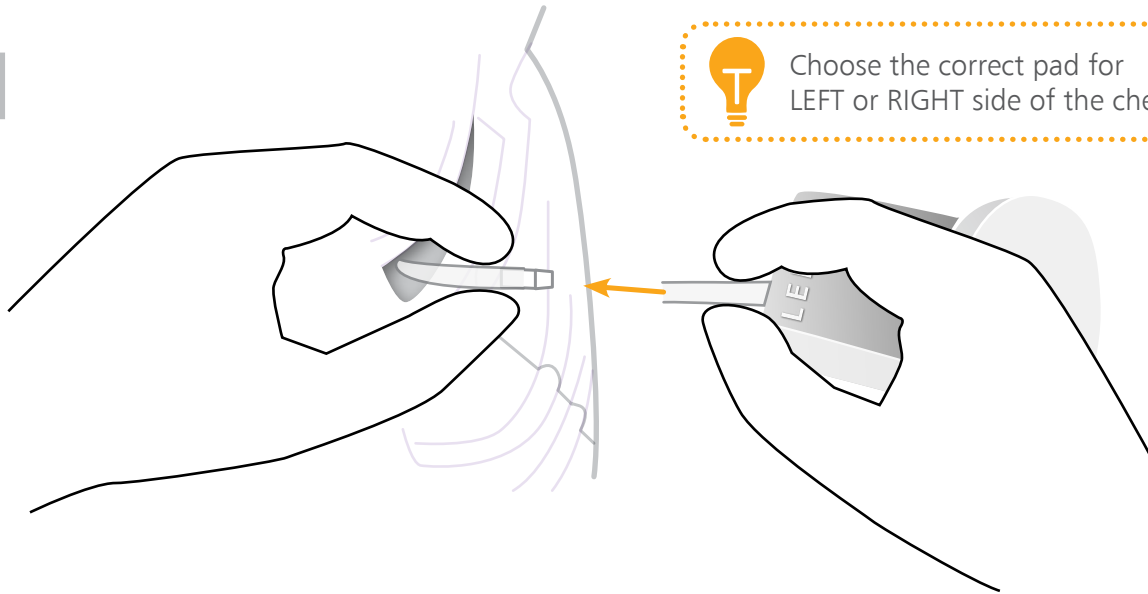

2

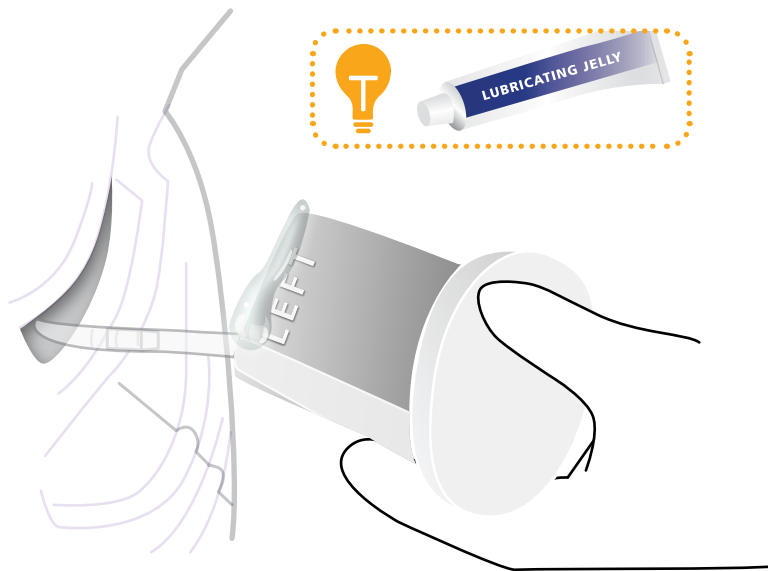

3

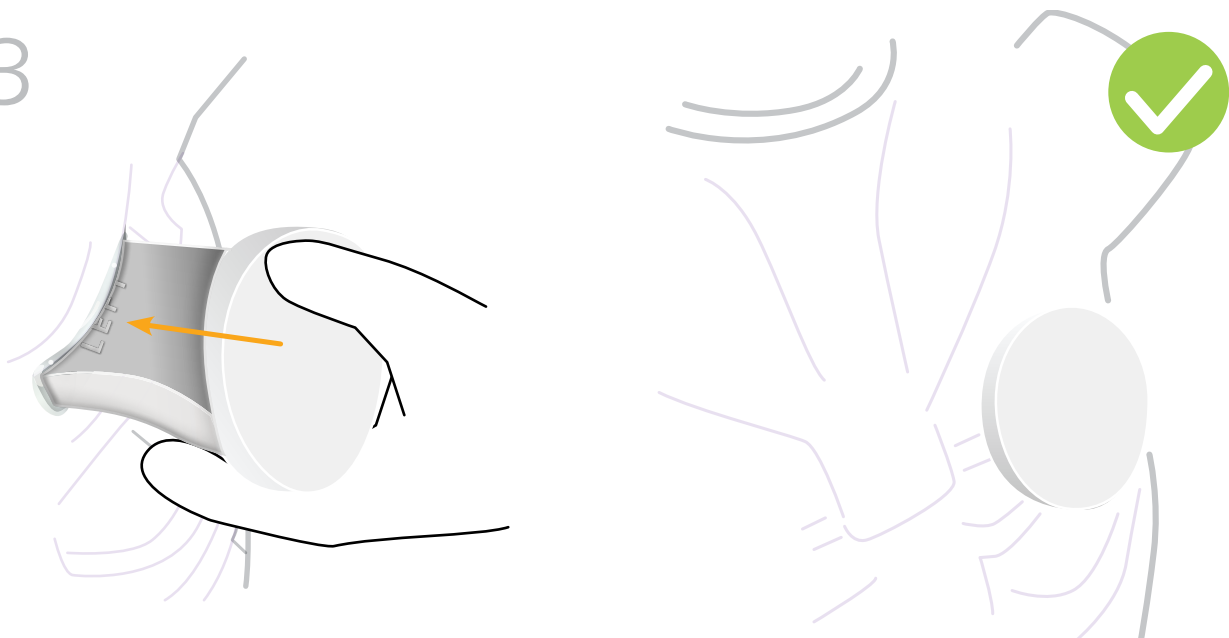

FILLING THE CHEST RESERVOIRS

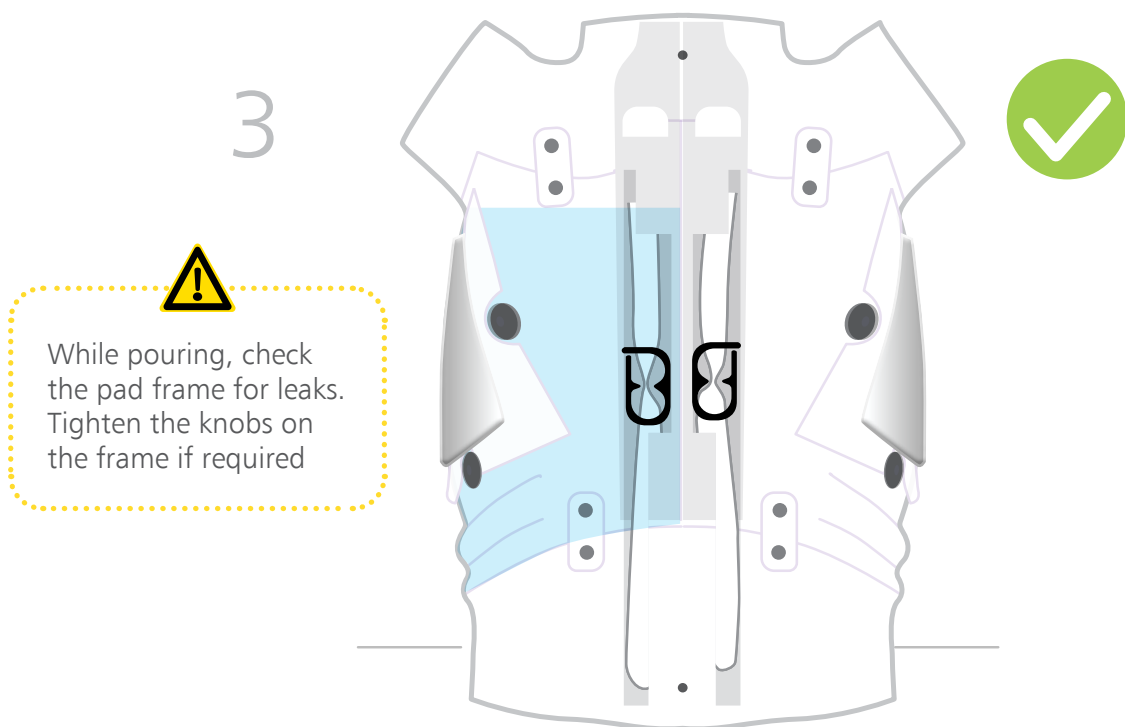
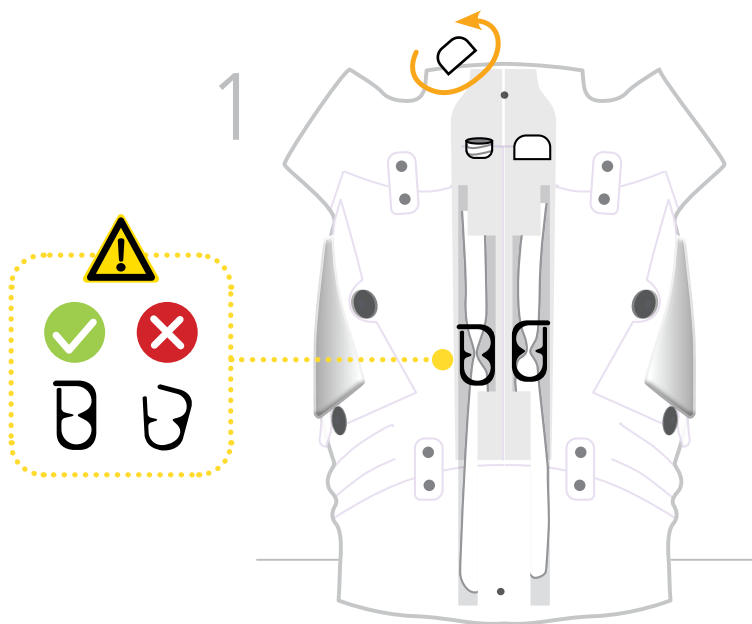

USING THE NEEDLE DECOMPRESSION PUMP

1



The left and right systems function independently

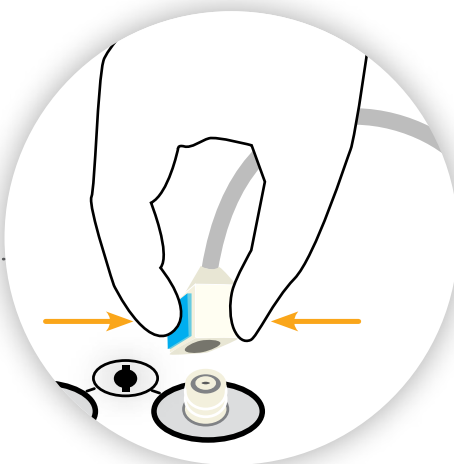
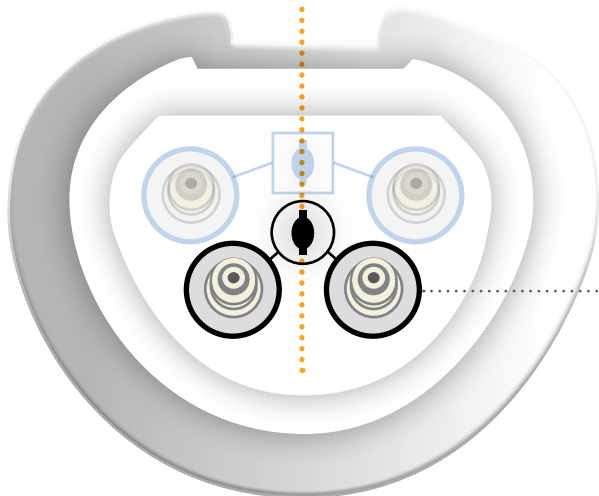

2



Release any residual air in the system

3



Close the bleed valve

4

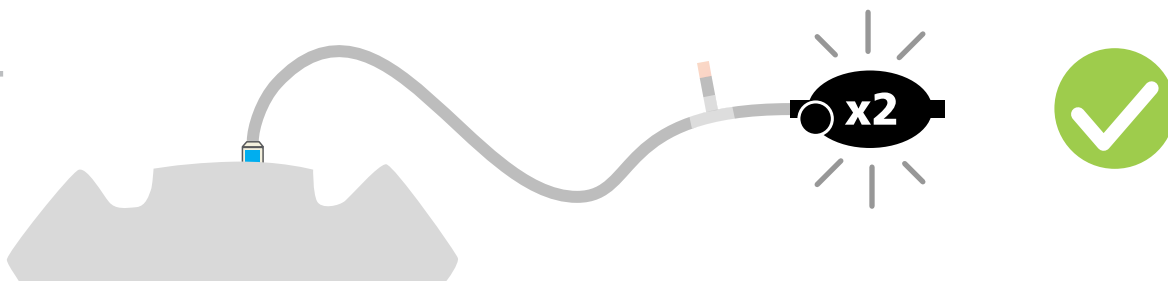

Tip for 5th intercostal space decompression (black pump to blue connectors)

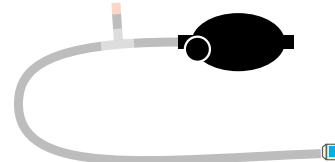
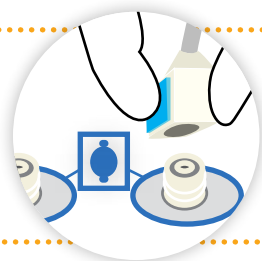

USING THE RESPIRATORY SWING PUMP

1



The left and right systems function independently

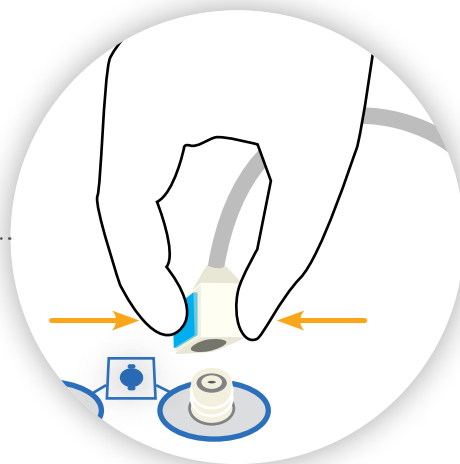
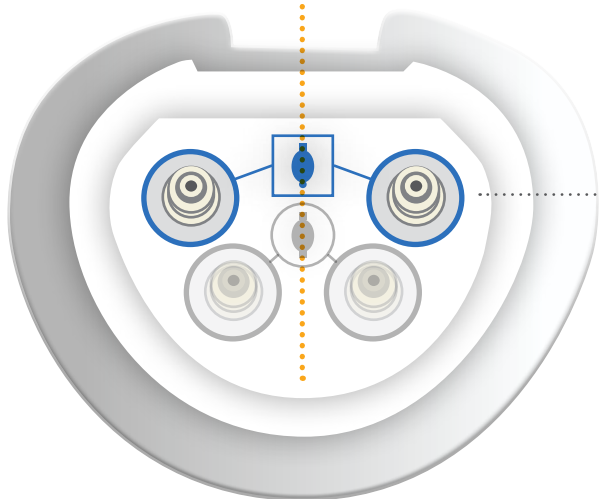

2



To reproduce **respiratory swing**: keep your thumb in position and alternately squeeze and release the pump to make the fluid level rise and fall.

To reproduce the **bubbling effect of coughing**, squeeze the pump hard while keeping your thumb over the inlet.

3

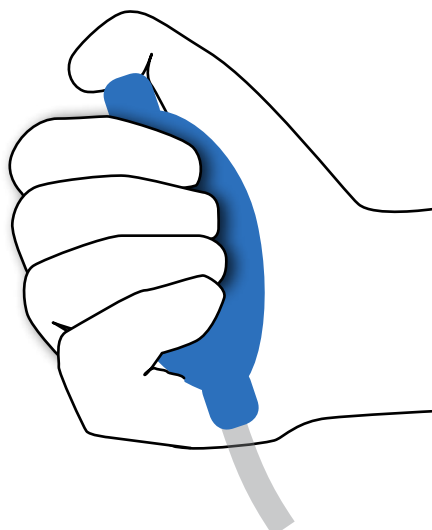

CLEANING & STORAGE

EMPTYING THE CHEST RESERVOIRS

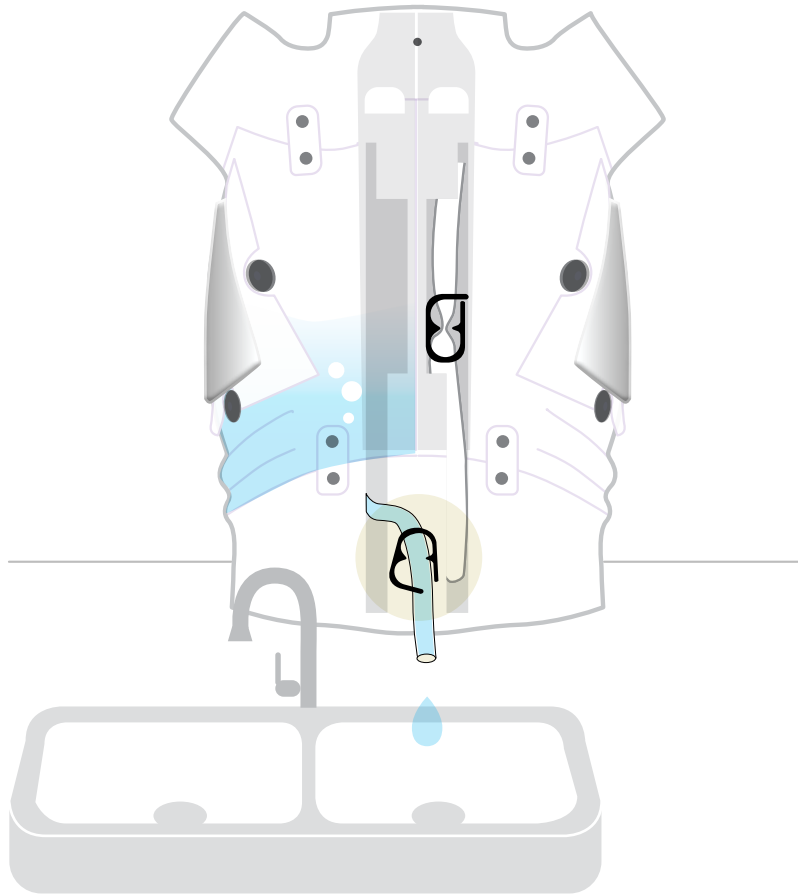

REMOVING/FITTING THE LUNG & DIAPHRAGM

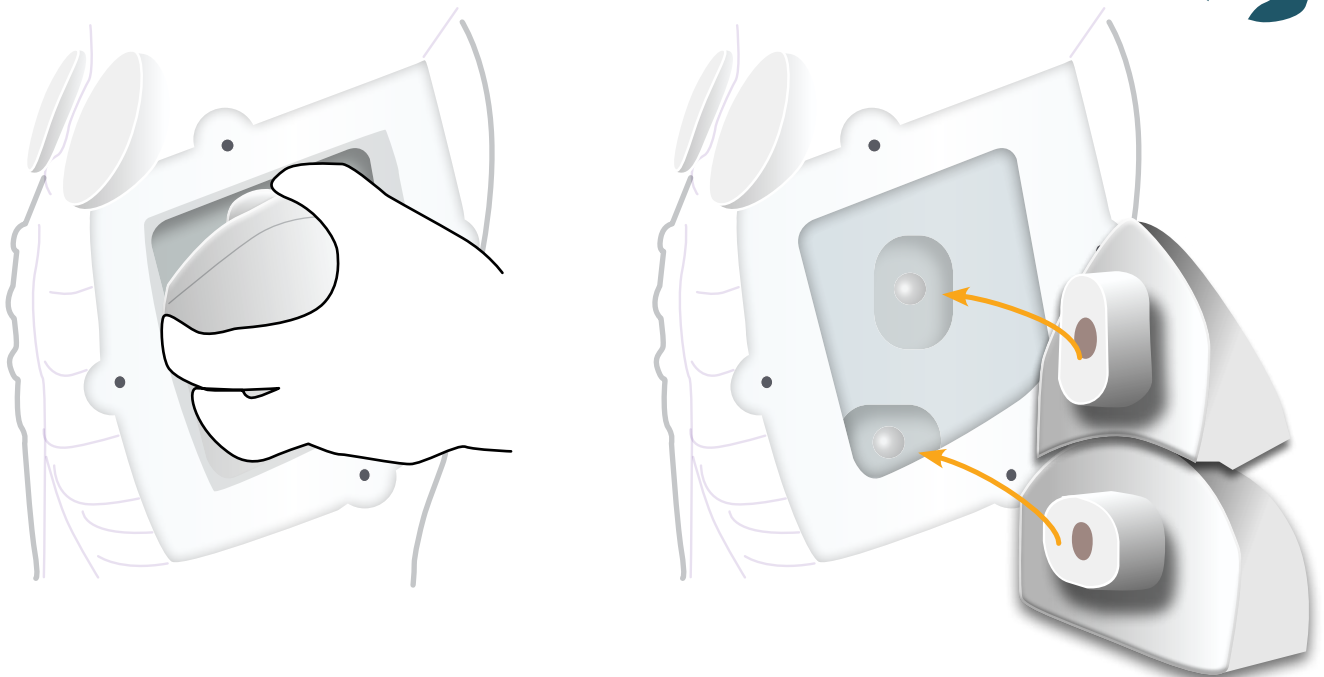



AUGMENTED REALITY TRAINING (ART)

for your Chest Drain Simulator

SAFETY & CLEANING INSTRUCTIONS

Read the safety instructions carefully before using your ART Mat

DO's



Follow all instructions. Keep these instructions. Heed all warnings

Use mat on flat surface

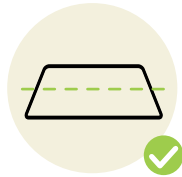

Only use attachments/accessories specified by Limbs & Things

Refer all servicing to qualified service personnel. Servicing is required when the apparatus has been damaged



DON'Ts



Do not install near any heat sources, do not expose the product to flames or use near naked flame sources. Do not use flammable solvents near or on this product

Do not set up the product near electrical appliances or items damaged by water



Do not cover the graphic of the mat with other items

Do not move the mat with a model on top of it



STORAGE



Store rolled up with print on the outside



Don't fold

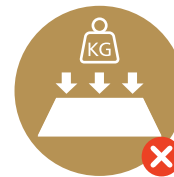

Don't place heavy objects on top

CLEANING



Can be cleaned with water, soap and non-alcoholic cleaning agents



Avoid abrasive and alcoholic cleaning agents



Make sure mat is dry before storing

ART SET UP

1

Take the mat out of tube

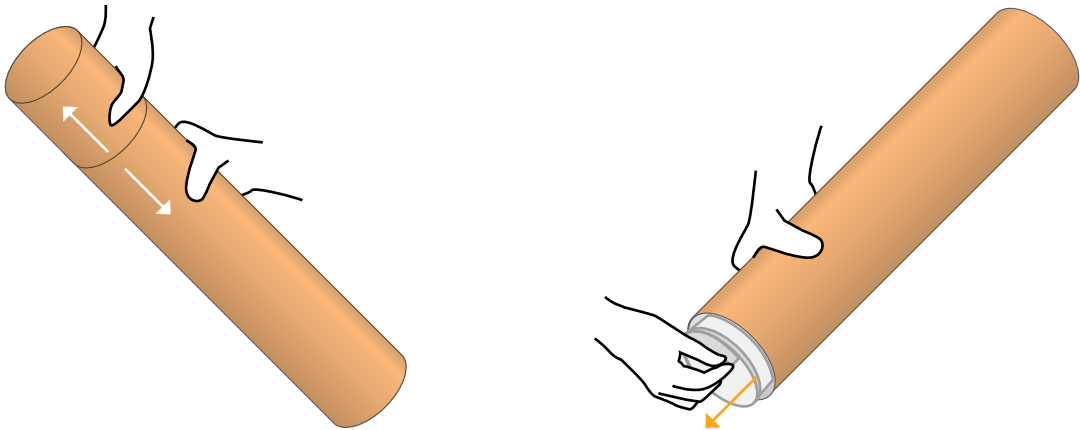

2

Place the mat on a table

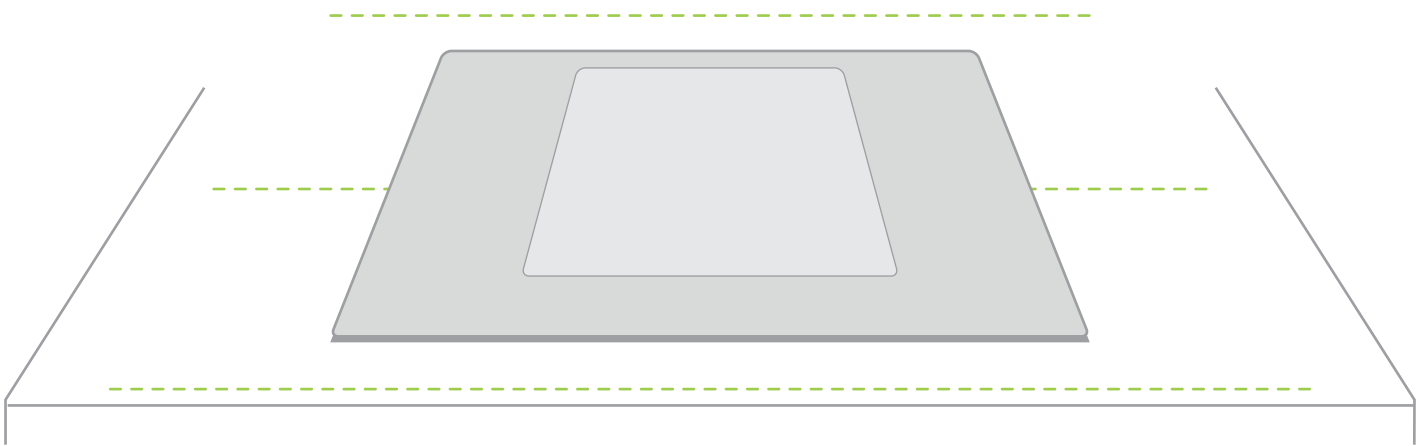

Note: Diagrams are for illustrative purposes, your product may differ from the example shown

3

Place the the model on the designated area of the mat

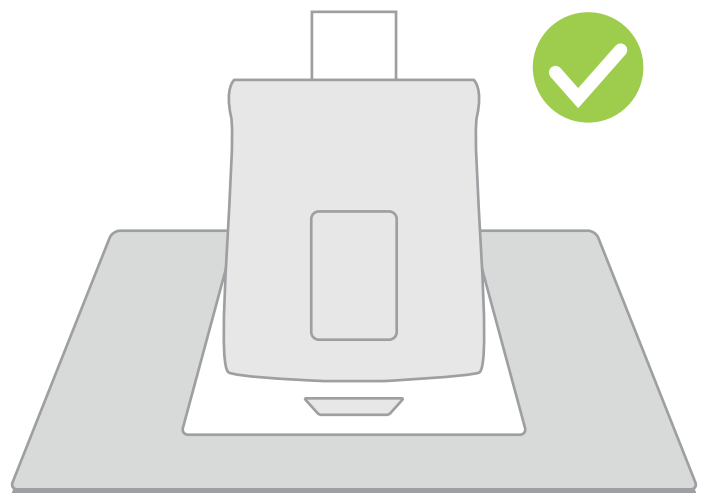
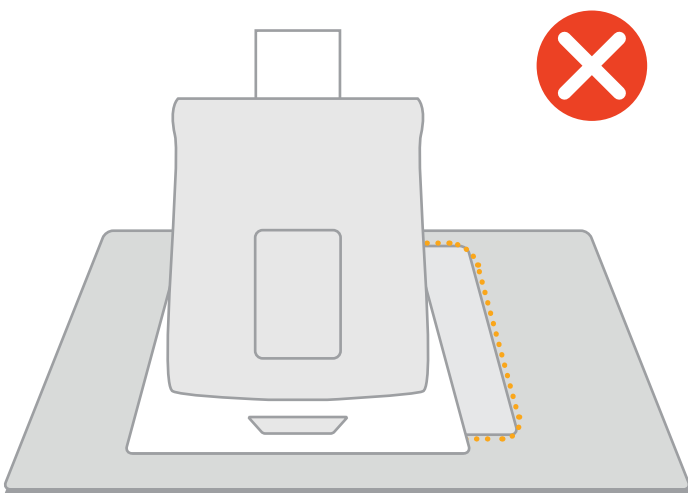
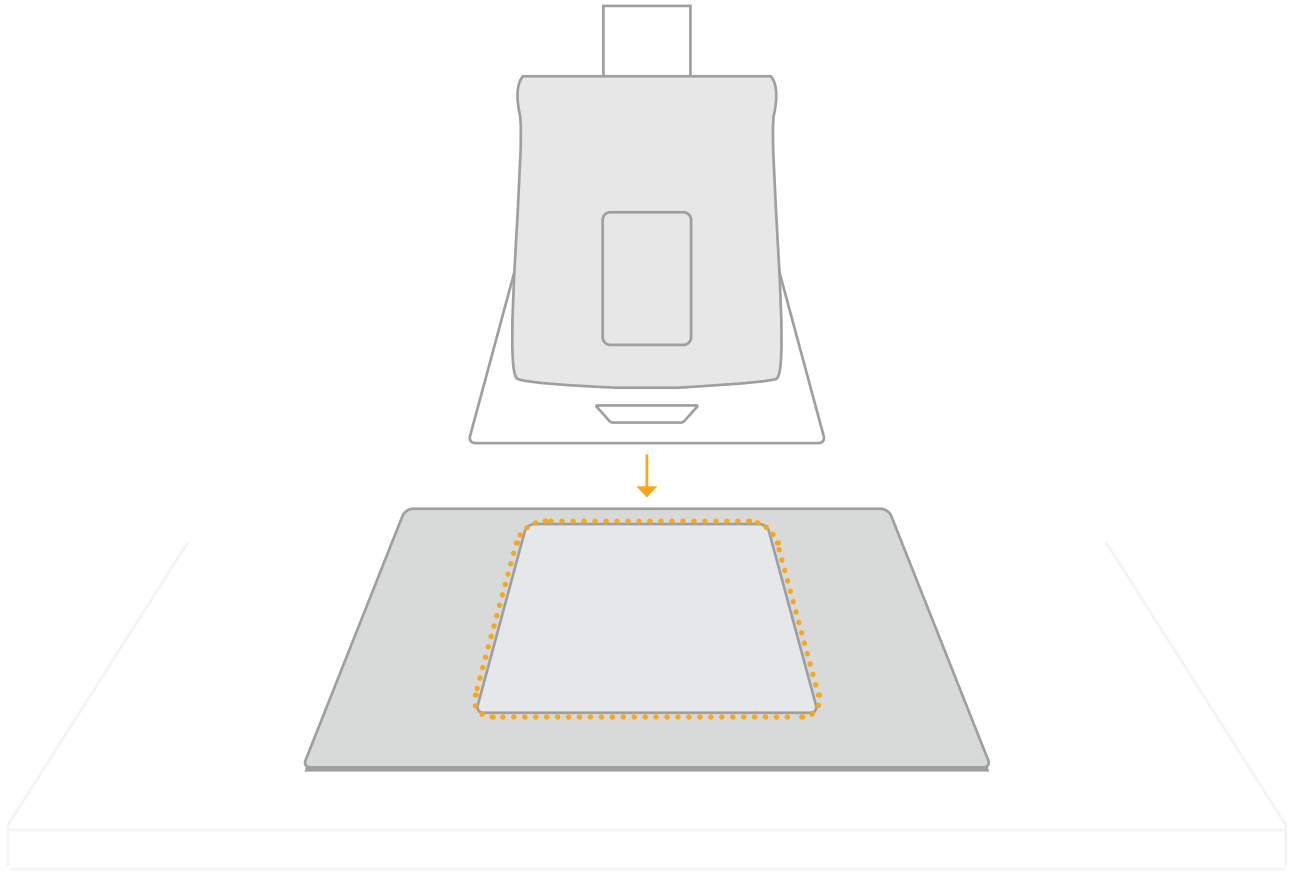

Note: Diagrams are for illustrative purposes, your product may differ from the example shown

Use the A.R.T. app to scan the mat

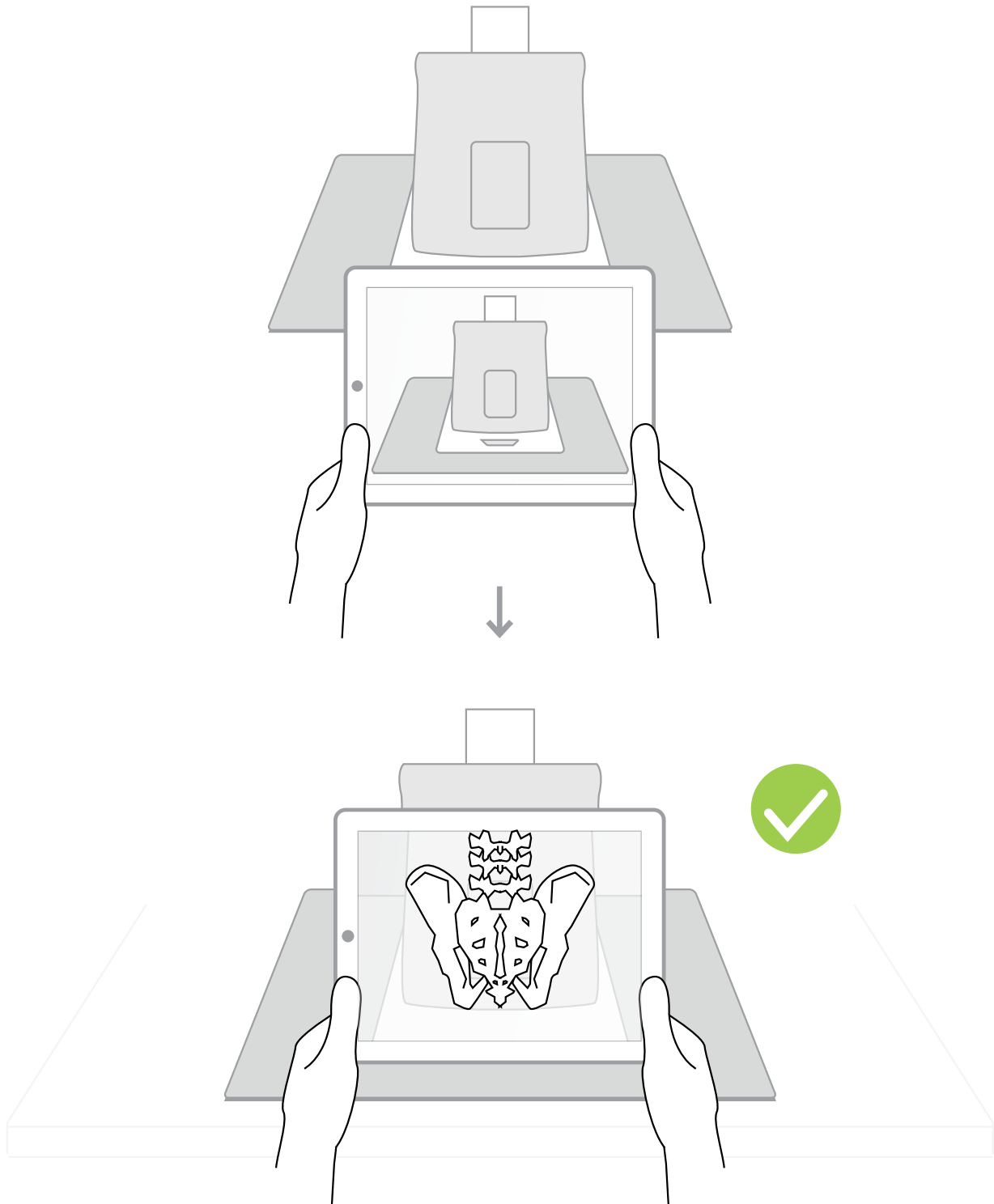

For app troubleshooting please visit the website.

Note: Diagrams are for illustrative purposes, your product may differ from the example shown

YOU MAY
ALSO BE
INTERESTED IN...

PARACENTESIS
TRAINER

60100 60111



ABDOMINAL
EXAMINATION
TRAINER

60000 60054

