



USER GUIDE



MALE CATHETERIZATION TRAINER

This product is available
in light and dark skin tones

60850

60870

FOR MORE SKILLS TRAINING PRODUCTS VISIT

limbsandthings.com

Sussex Street, St Philips, Bristol, BS2 0RA, UK | sales@limbsandthings.com | +44 (0) 117 311 0500

PACKAGE SUPPLIED	3
SAFETY & CLEANING INSTRUCTIONS	4
SET UP	5
• PLACING PELVIC SHELL	5
• FITTING THE FORESKIN	6
• ASSEMBLING THE WATER SYSTEM	7
• EMPTYING WATER	9
• REASSEMBLY	10
AUGMENTED REALITY TRAINING (ART)	12
• SAFETY & CLEANING INSTRUCTIONS	12
• ART SET UP	13

TAKE A LOOK
AT OUR **VIDEO**



VISIT THE WEBSITE
limbsandthings.com

OR YOUTUBE CHANNEL
youtube.com/limbsandthings

PACKAGE SUPPLIED

Male Catheterization Module

60850

60874



Water System

60893



Pelvic Shell & Stand

60864

60881

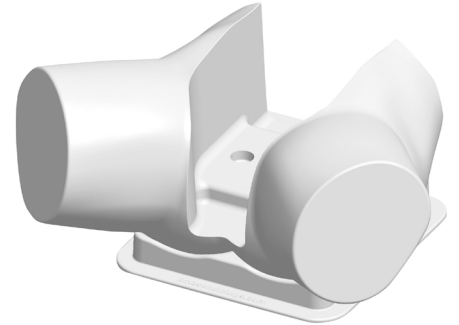

Catheterization Foreskins (x3)

60859

60878

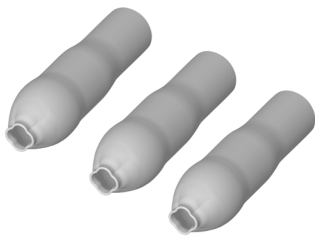

Aseptic Catheterization Sleeves (x2)

60862



Lubricant Gel with Syringe

60892

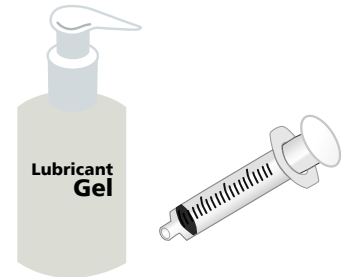

Antifungal Agent (Milton)

50185



Plastic Kidney Dish

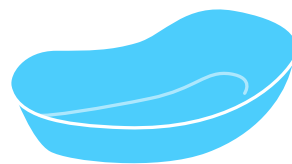

14 French Foley Catheter

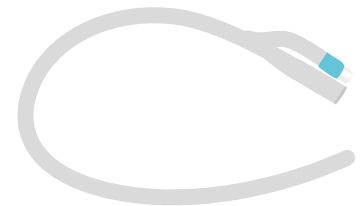

Water Extension Tubing

60867

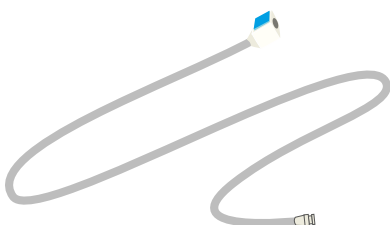

ART mat

60131

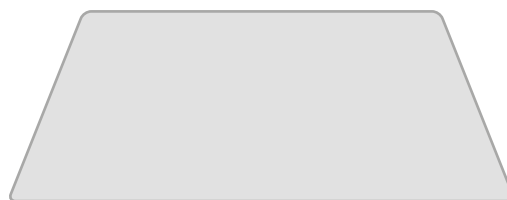

SAFETY & CLEANING INSTRUCTIONS

READ THE SAFETY INSTRUCTIONS CAREFULLY BEFORE USING YOUR CATHETERIZATION TRAINER

DO's



Follow all instructions. Keep these instructions. Heed all warnings.

Only use attachments/accessories specified by Limbs & Things.



Refer all servicing to qualified service personnel. Servicing is required when the apparatus has been damaged.

Wear gloves at all times and remove all jewellery items. Sharp surfaces such as finger nails and rings can lead to damage of silicone parts.



Use lubrication when inserting catheter.

Use only the Milton Antifungal agent supplied to sterilize water.



Use 14 French Foley catheter (male length).

Drain all water from the product and clean with a damp soft cloth or sponge, using only warm water with mild detergent.



DON'Ts



Do not install near any heat sources, do not expose the product to flames or use near naked flame sources. Do not use flammable solvents near or on this product.

Do not set up the product near electrical appliances or items damaged by water.



Do not leave catheters inserted in the Trainer.

Do not attempt to remove a catheter which has an inflated balloon.



Do not use anaesthetic gel – use mock gel supplied with trainer.

Do not disassemble the product or attempt to repair a faulty unit, please return the product to Limbs & Things for assessment and repair.



Do not leave trainer set up with water in. Disassemble & clean after every use.

STORAGE & TRANSPORTATION



Always ensure that the product is properly packed and secured during transportation and storage in order to prevent personal injury or damage to the product.

1

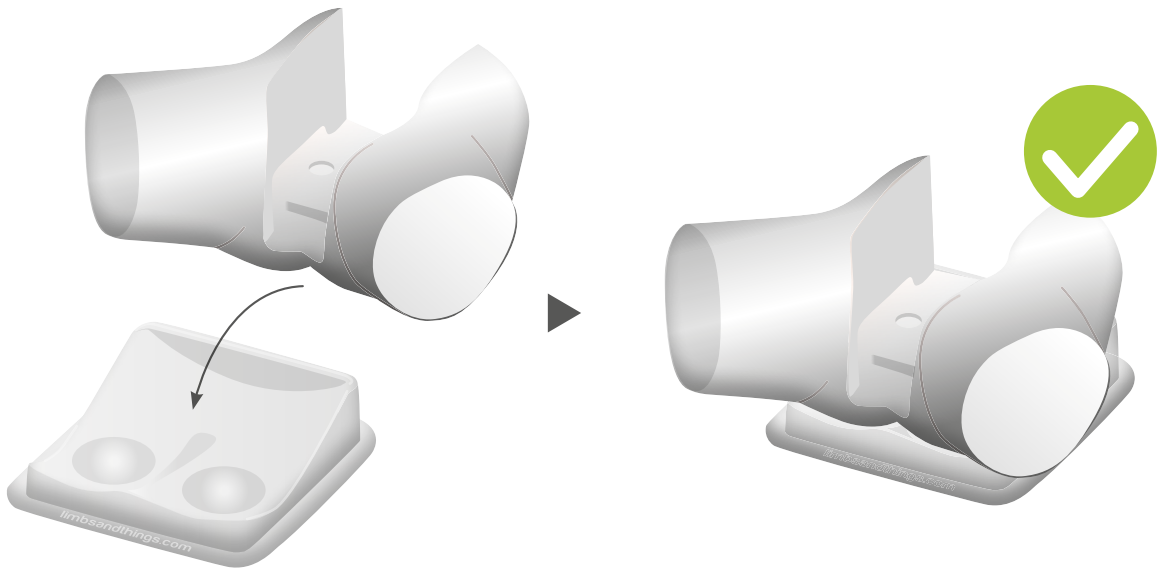

2

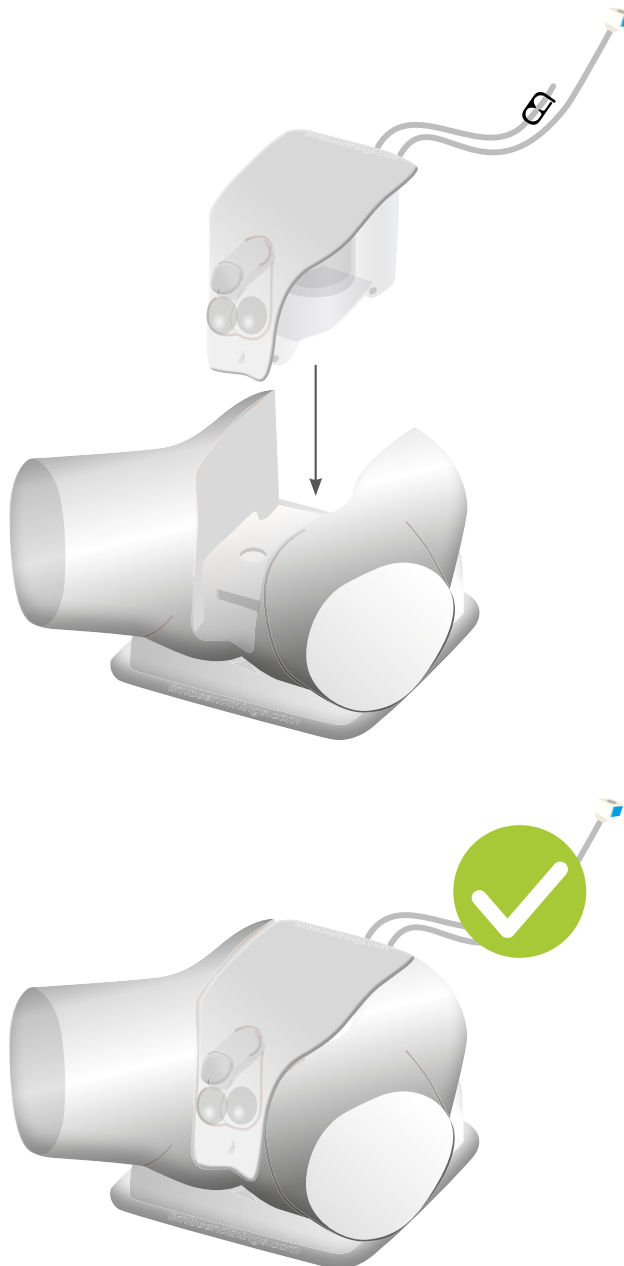

1

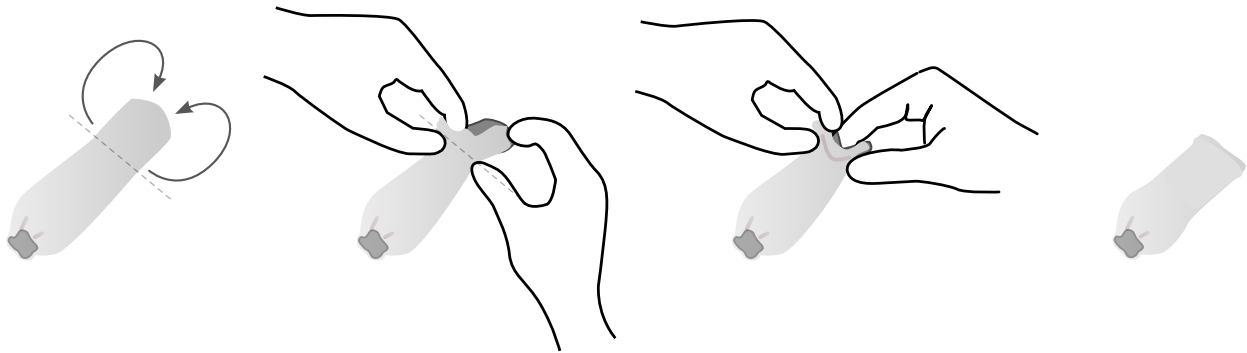

2

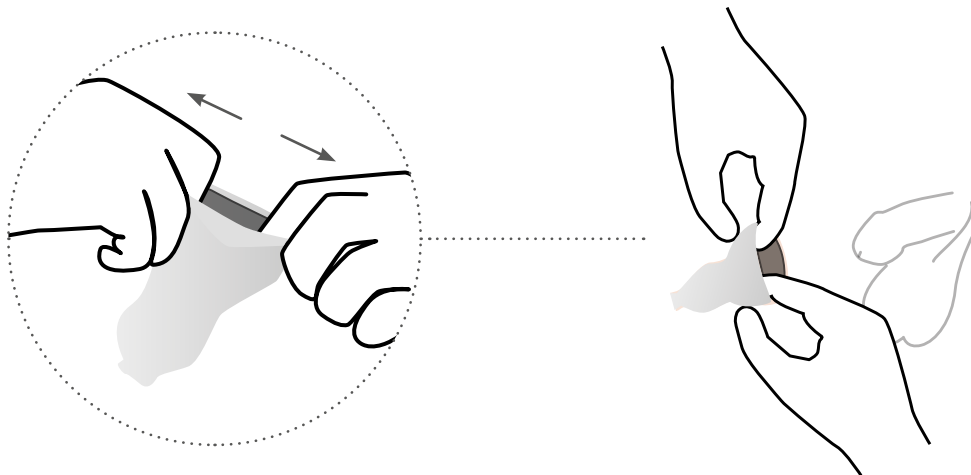

3

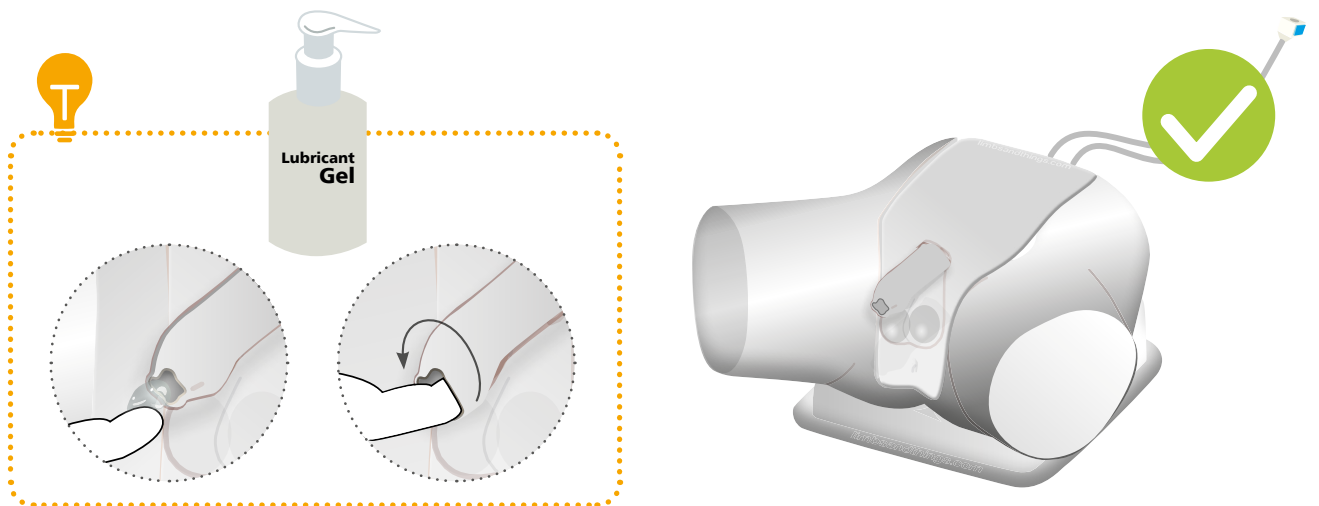

SET UP

ASSEMBLING THE WATER SYSTEM

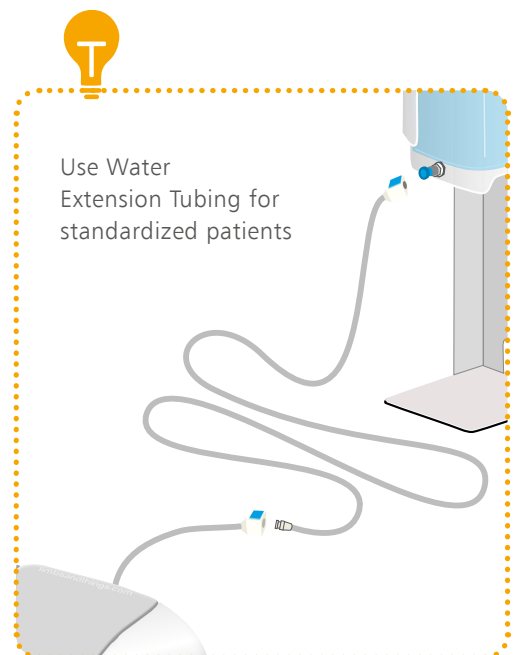
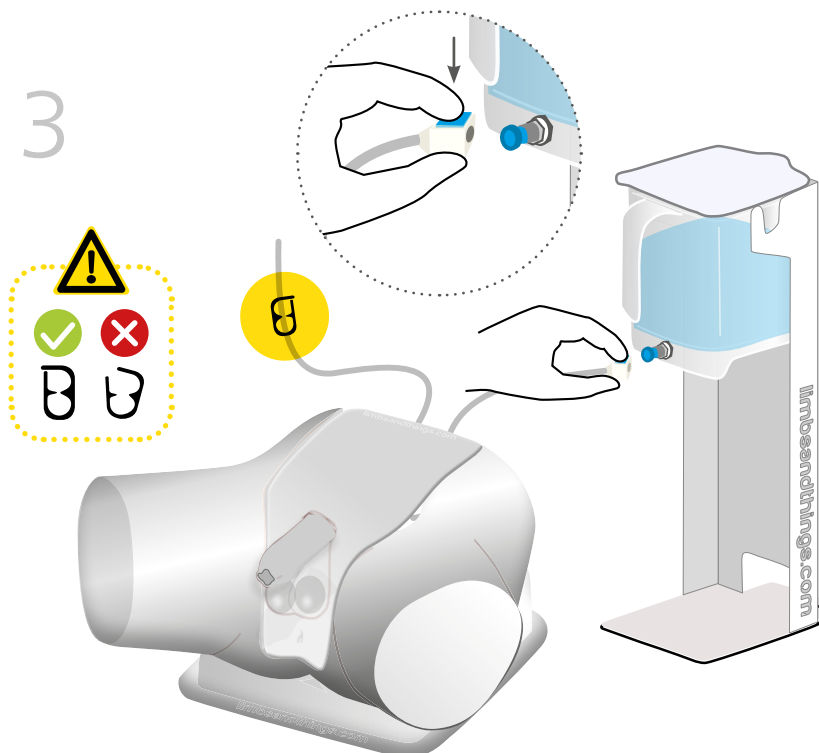
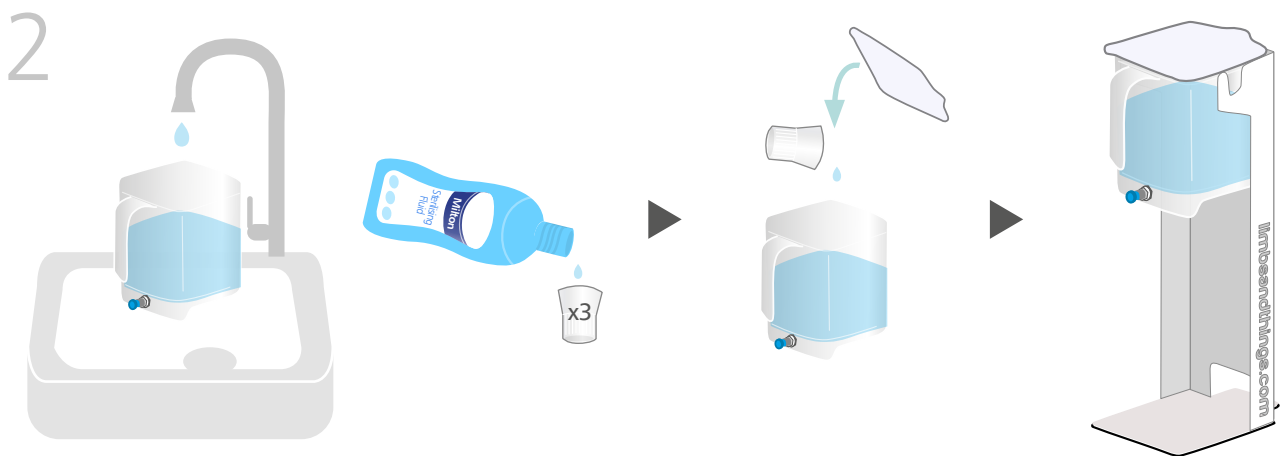
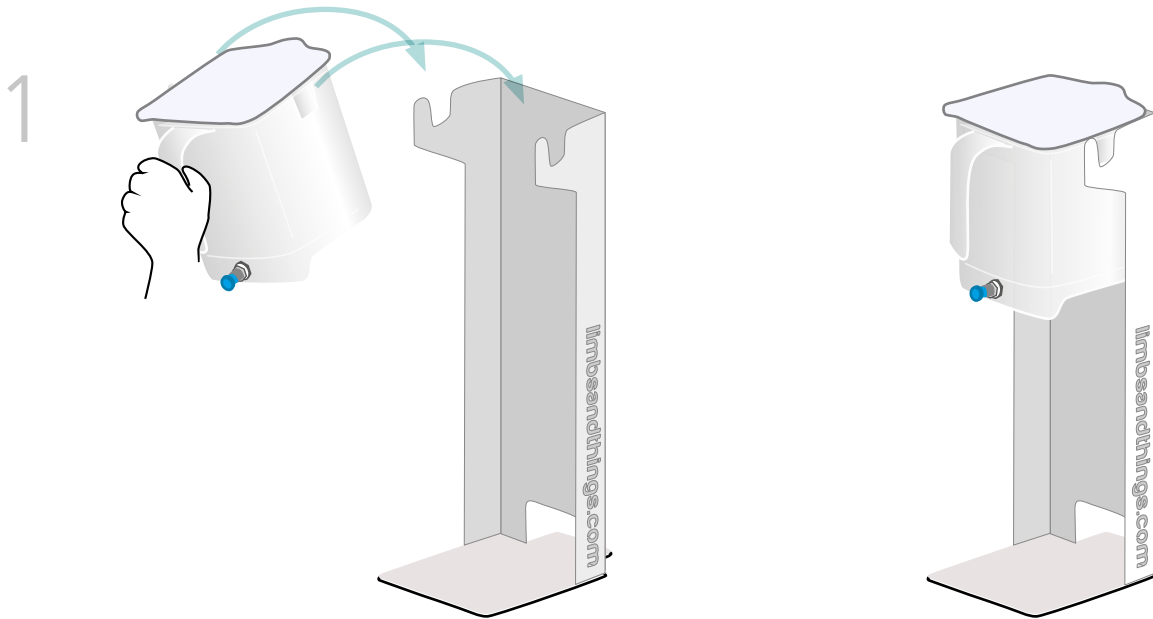

SET UP

ASSEMBLING THE WATER SYSTEM

4

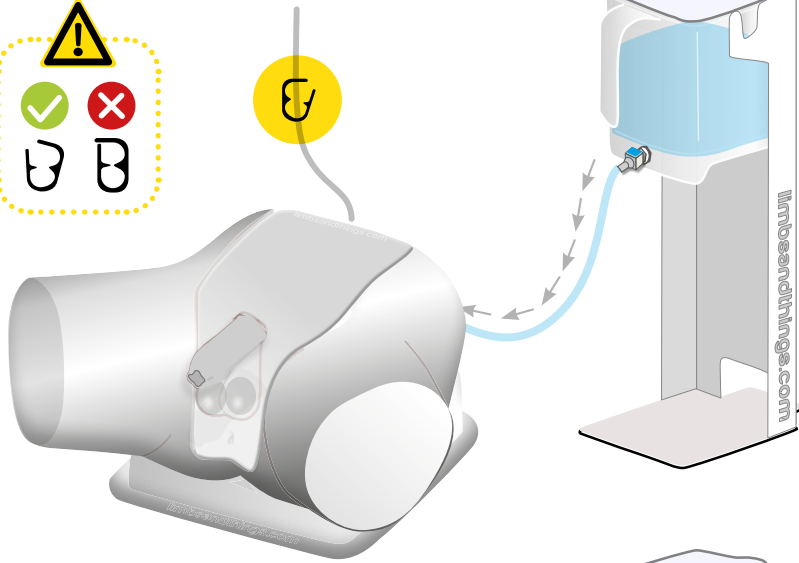

5

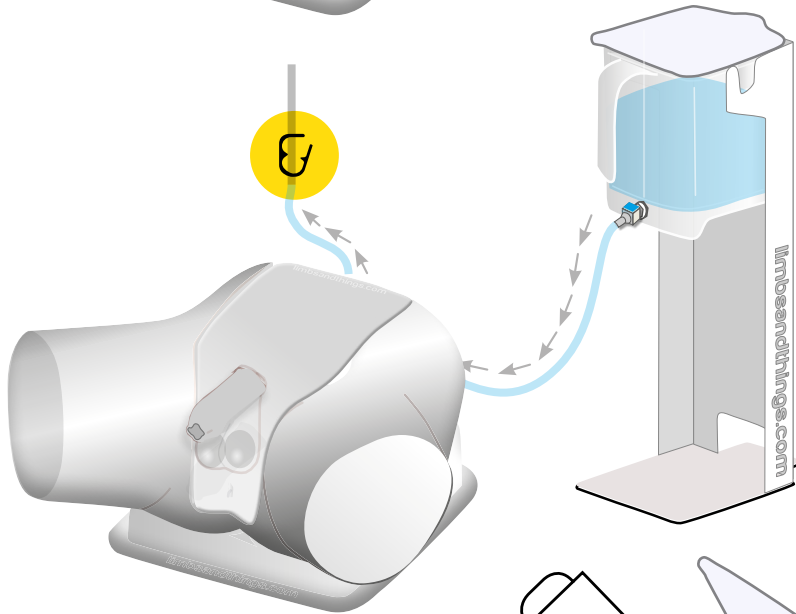

6

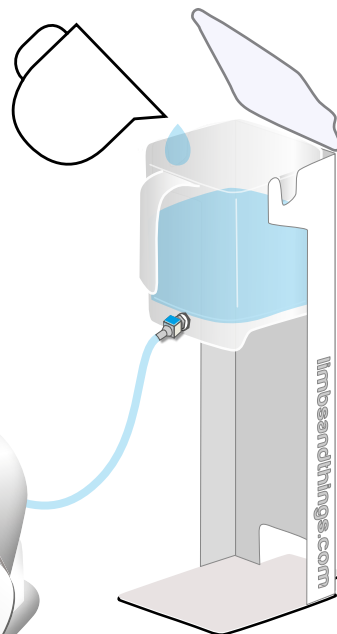

10ml during set up.
5-10ml per catheter
insertion

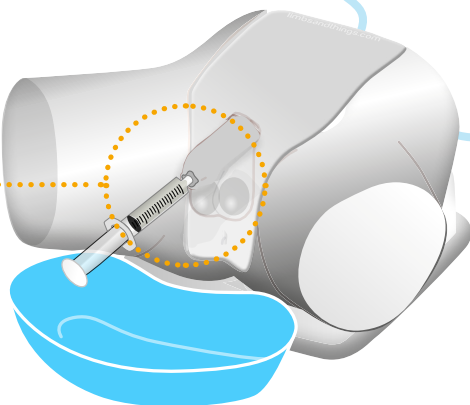

SET UP

EMPTYING WATER

1

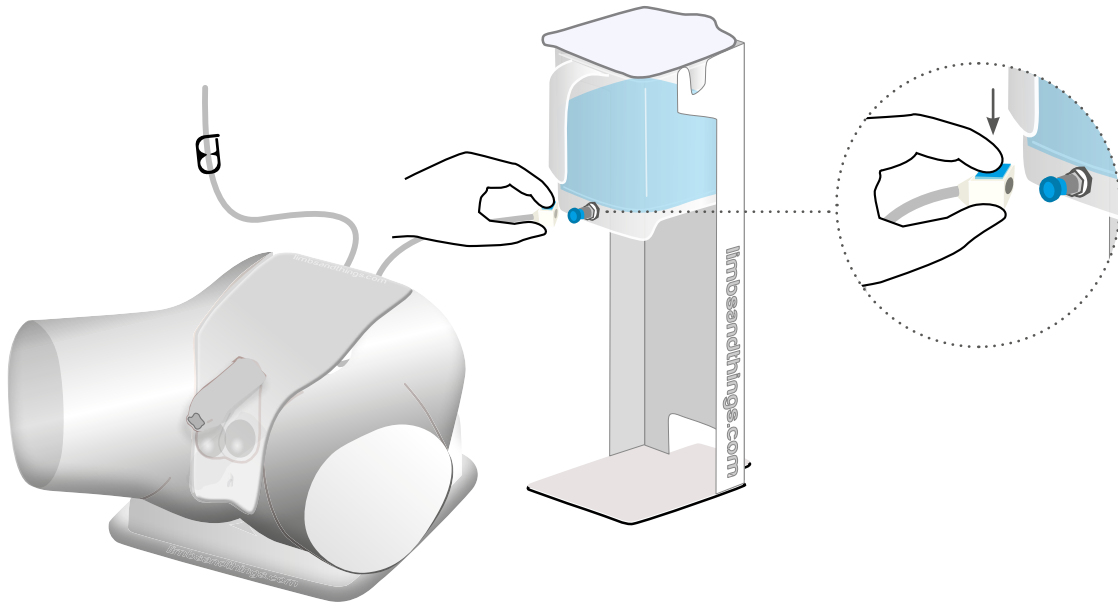

2

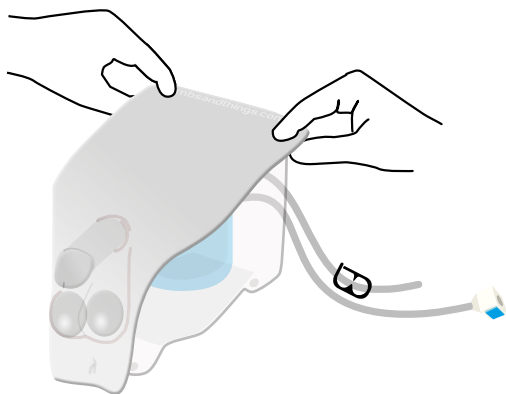

3

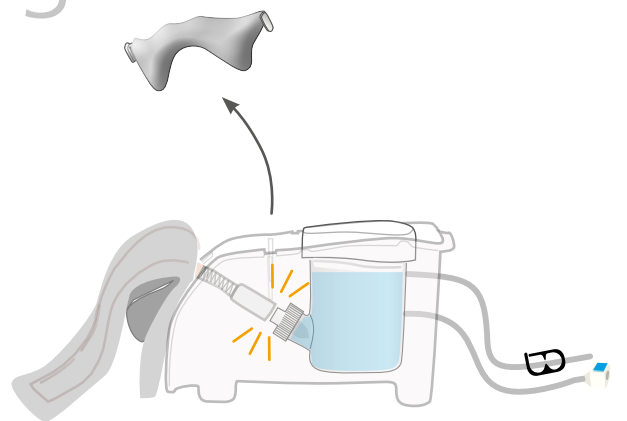

4



Dry all parts with paper towel
Reassemble and put in box

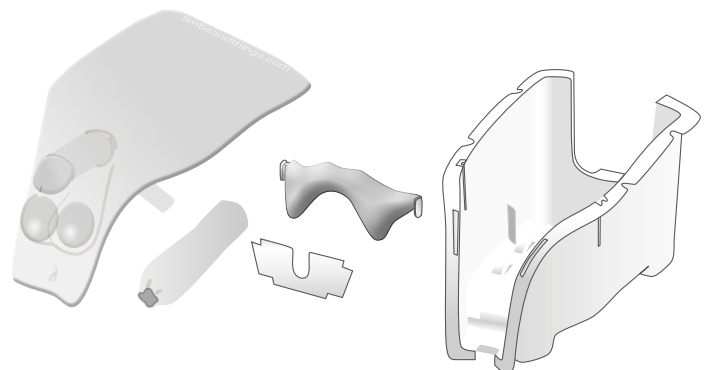

1

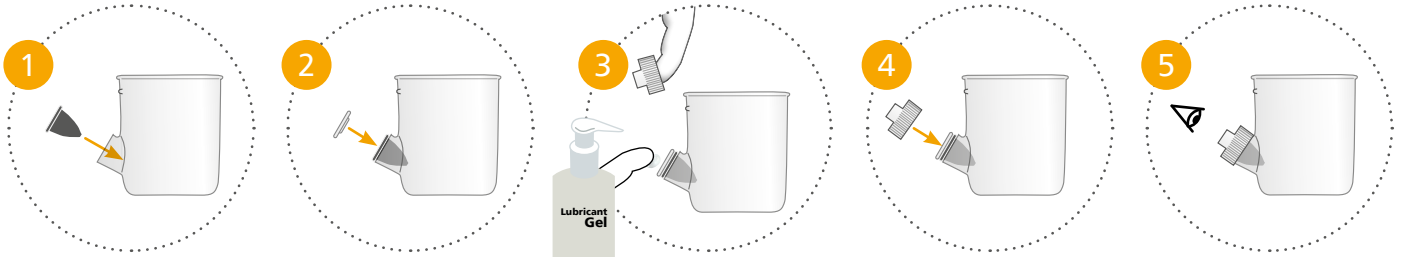
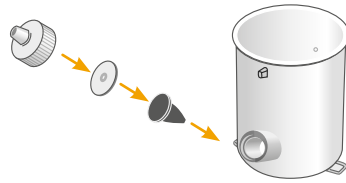

⚡
Add lubrication to diaphragm before replacing lid

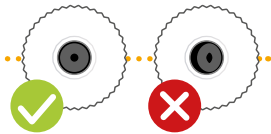

2

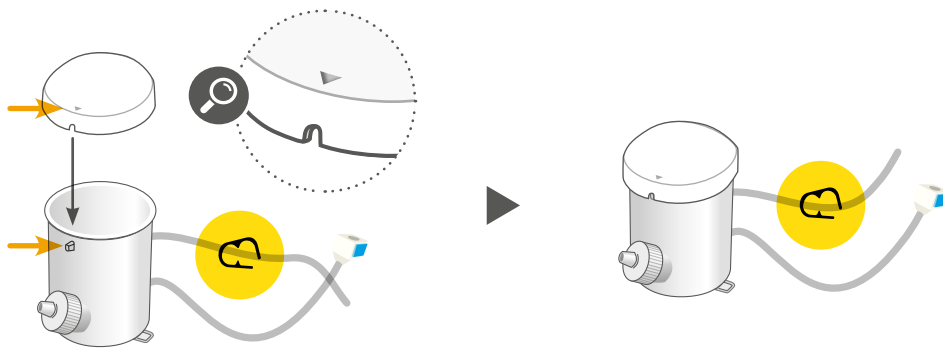

3

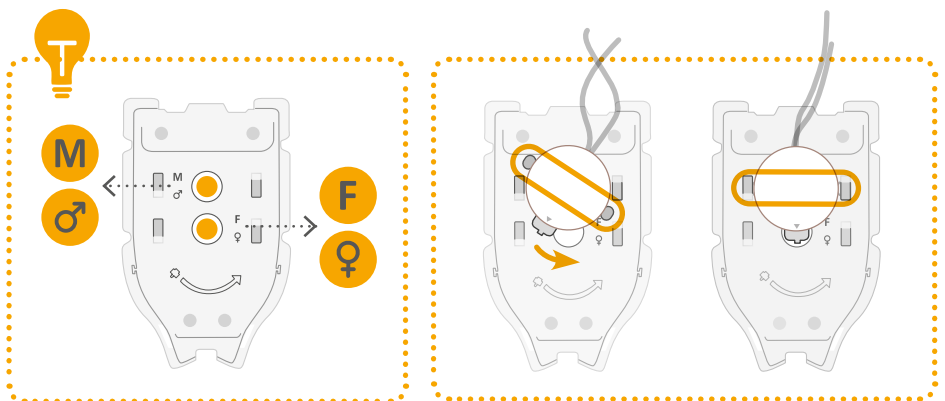
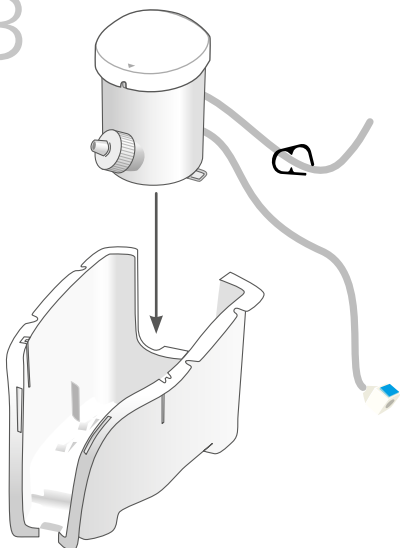

4

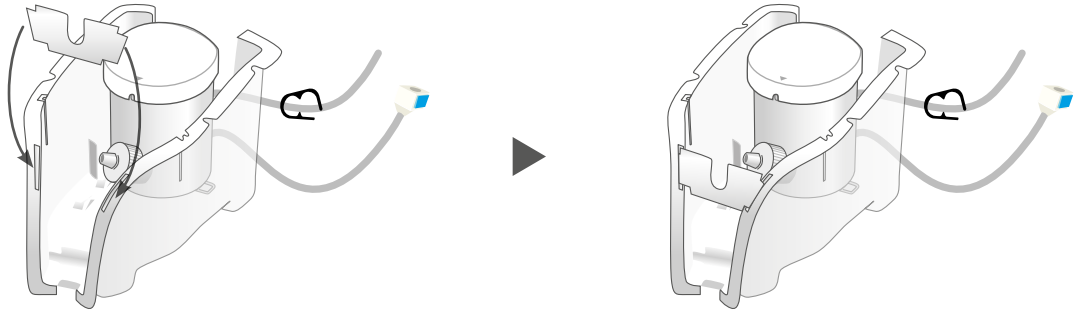

5

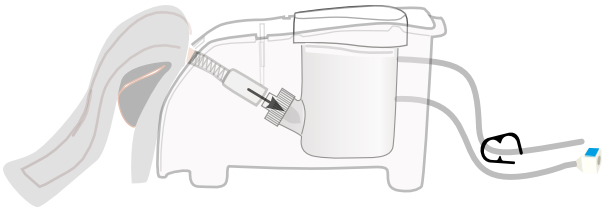

6

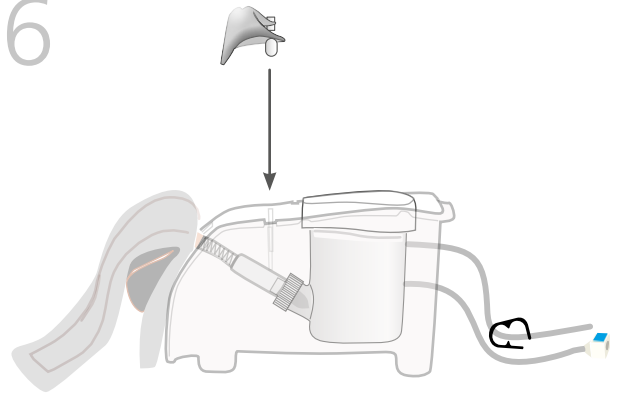

7

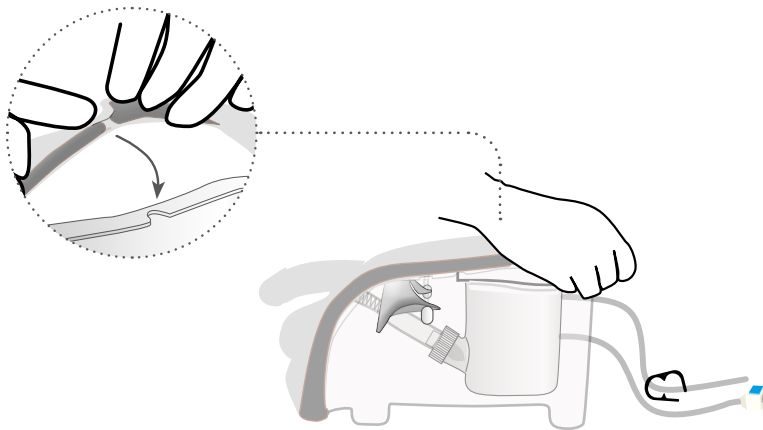



AUGMENTED REALITY TRAINING (ART)

for your Catheterization Trainer

SAFETY & CLEANING INSTRUCTIONS

Read the safety instructions carefully before using your ART Mat

DO's



Follow all instructions. Keep these instructions. Heed all warnings

Use mat on flat surface

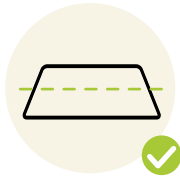

Only use attachments/accessories specified by Limbs & Things

Refer all servicing to qualified service personnel. Servicing is required when the apparatus has been damaged



DON'Ts



Do not install near any heat sources, do not expose the product to flames or use near naked flame sources. Do not use flammable solvents near or on this product

Do not set up the product near electrical appliances or items damaged by water



Do not cover the graphic of the mat with other items

Do not move the mat with a model on top of it



STORAGE



Store rolled up with print on the outside



Don't fold

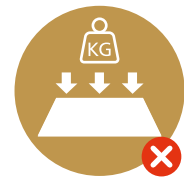

Don't place heavy objects on top

CLEANING



Can be cleaned with water, soap and non-alcoholic cleaning agents



Avoid abrasive and alcoholic cleaning agents



Make sure mat is dry before storing

ART SET UP

1

Take the mat out of tube

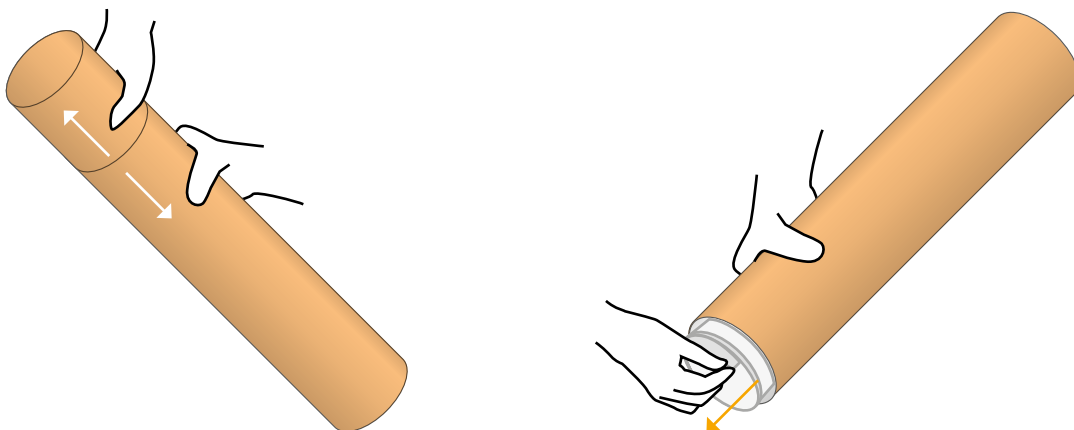

2

Place the mat on a table

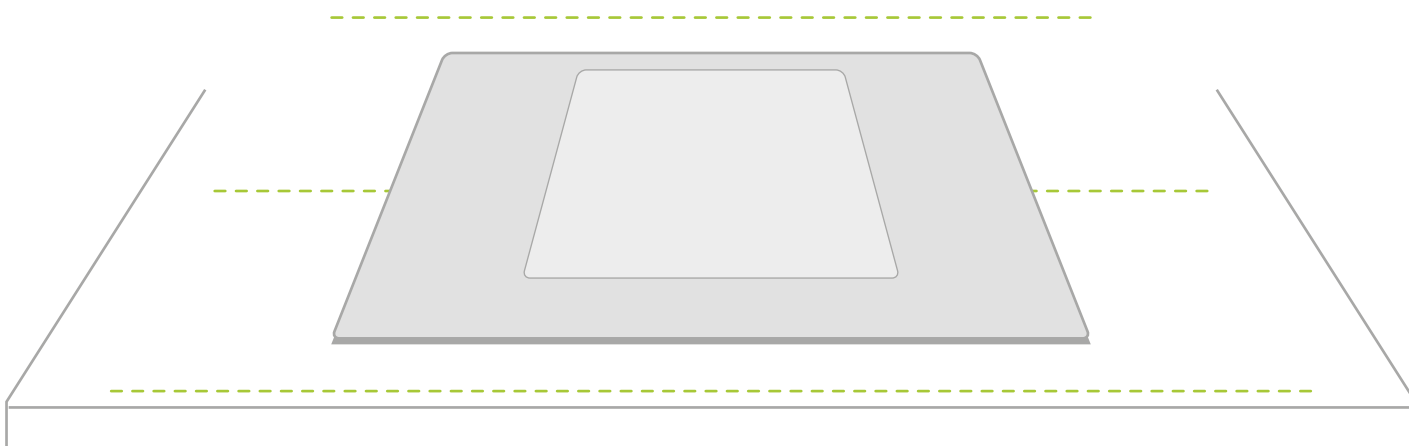

Note: Diagrams are for illustrative purposes, your product may differ from the example shown

3

Place the model on the designated area of the mat

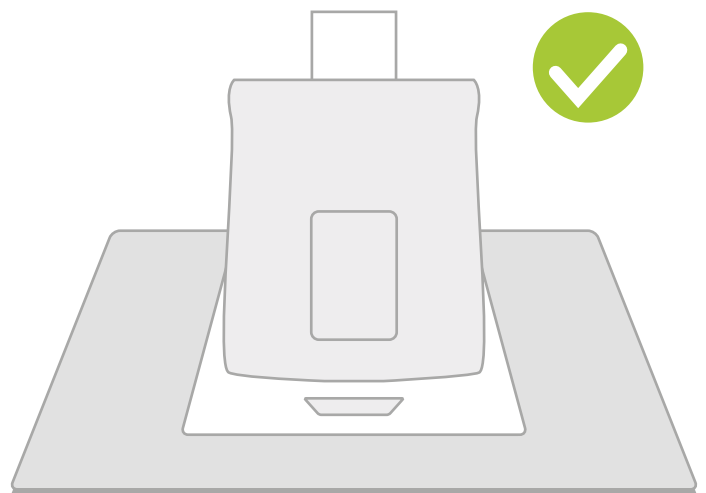
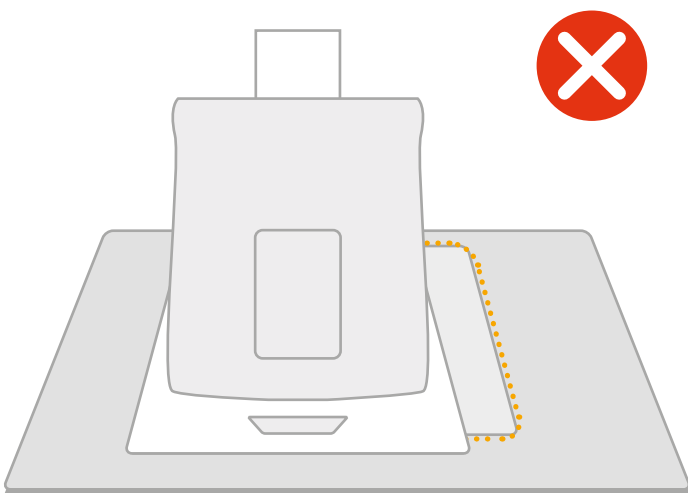
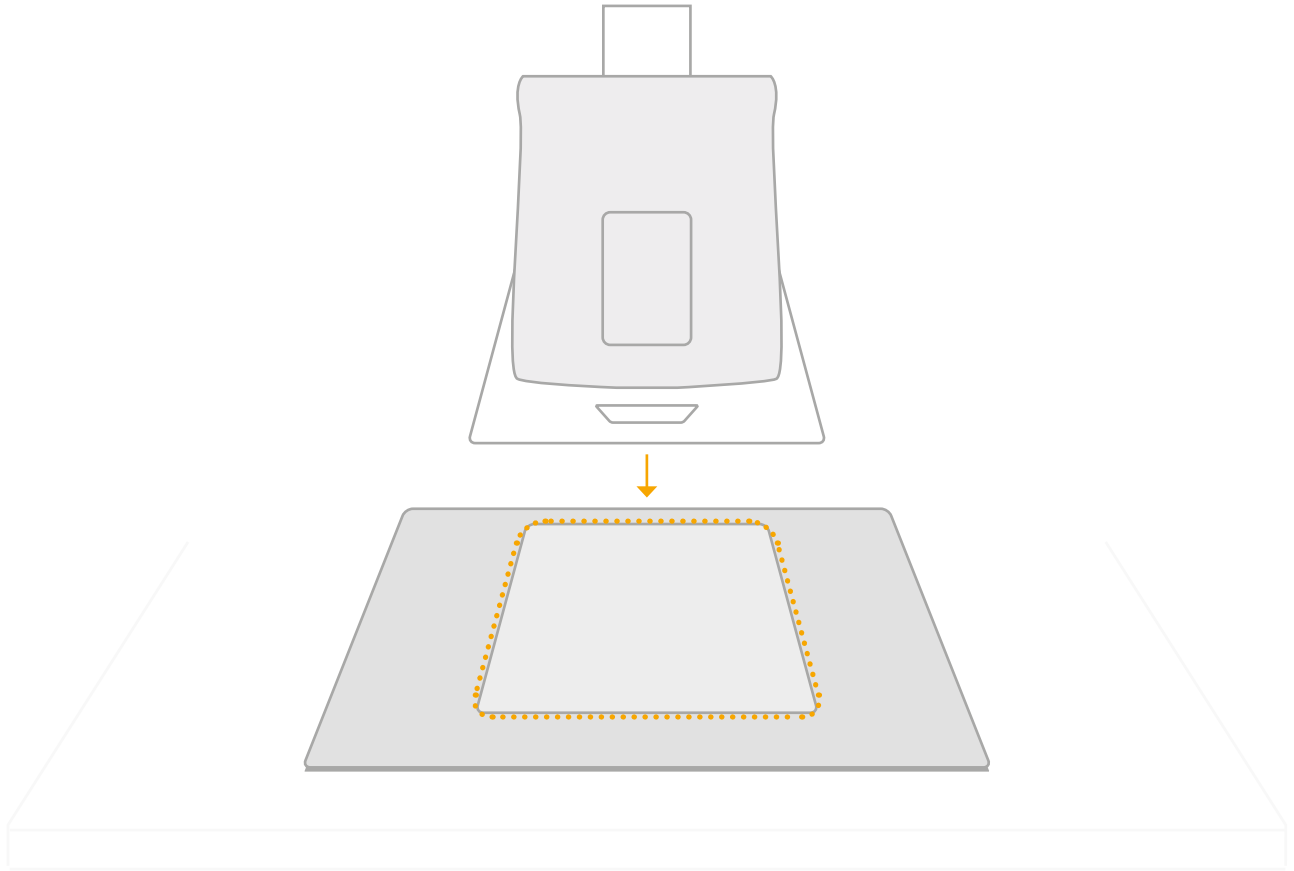

Note: Diagrams are for illustrative purposes, your product may differ from the example shown

Use the A.R.T. app to scan the mat

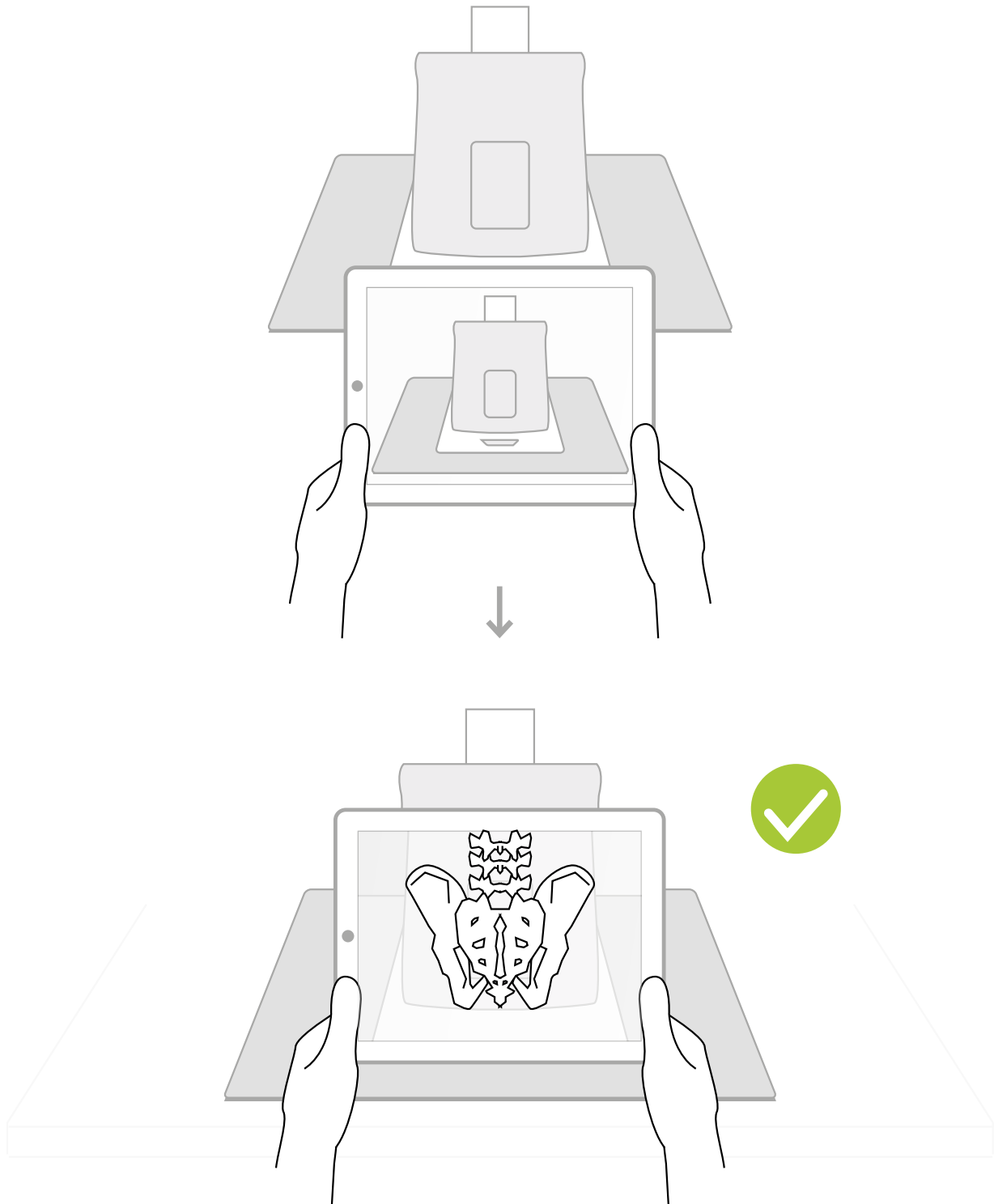

For app troubleshooting please visit the website.

Note: Diagrams are for illustrative purposes, your product may differ from the example shown

YOU MAY
ALSO BE
INTERESTED IN...

FEMALE
CATHETERIZATION
TRAINER

60851

60869

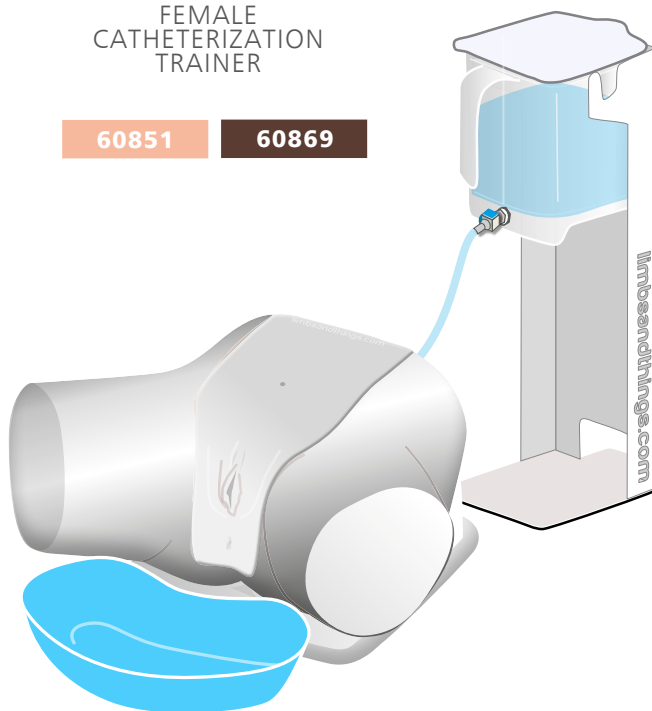

SUPRAPUBIC
INSERTION UNIT

60852

60873

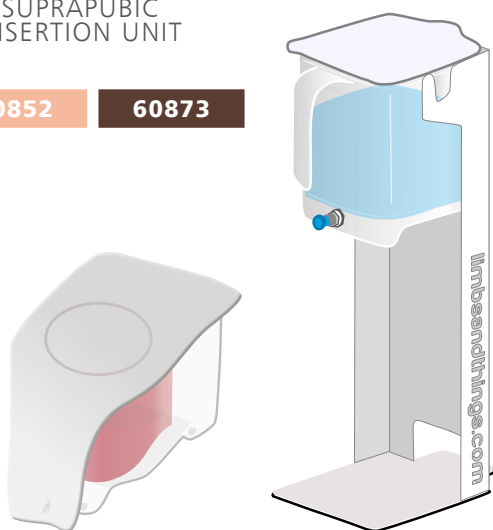

MEDIUM
CARRY CASE

40209

