

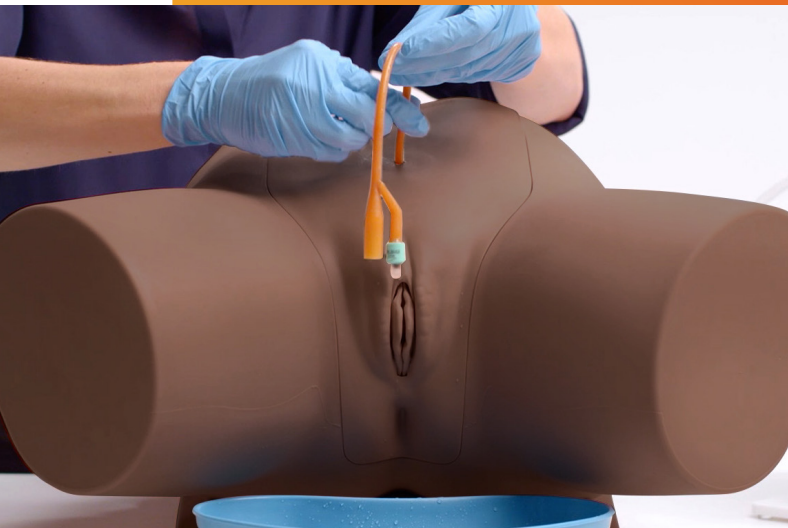

USER GUIDE

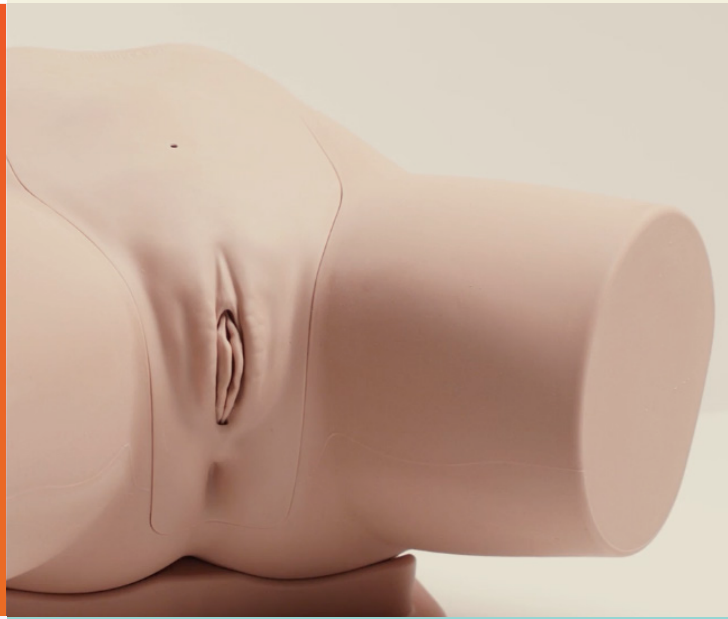

FEMALE CATHETERIZATION TRAINER

This product is available
in light and dark skin tones

60851

60869

FOR MORE SKILLS TRAINING PRODUCTS VISIT

limbsandthings.com

Sussex Street, St Philips, Bristol, BS2 0RA, UK | sales@limbsandthings.com | +44 (0) 117 311 0500

PACKAGE SUPPLIED	3
SAFETY & CLEANING INSTRUCTIONS	4
SET UP	5
• PLACING PELVIC SHELL	5
• ASSEMBLING THE WATER SYSTEM	6
• EMPTYING WATER	8
• REASSEMBLY	9
AUGMENTED REALITY TRAINING	12
• SAFETY & CLEANING INSTRUCTIONS	12
• AUGMENTED REALITY SET UP	13

TAKE A LOOK
AT OUR **VIDEO**



VISIT THE WEBSITE
limbsandthings.com

OR YOUTUBE CHANNEL
youtube.com/limbsandthings

PACKAGE SUPPLIED

Female Catheterization Module

60856

60875



Water System

60893



Pelvic Shell & Stand

60864

60881

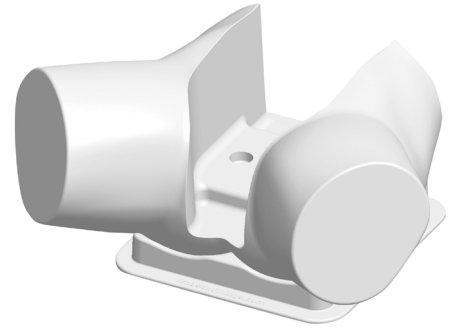

Aseptic Catheterization Sleeves (x2)

60862



Lubricant Gel with Syringe

60892

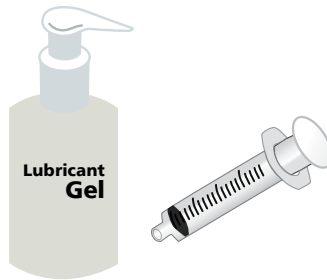

Antifungal Agent (Milton)

120-156

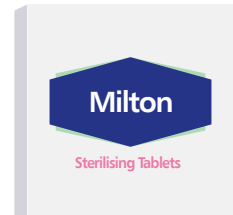

Water Extension Tubing

60867

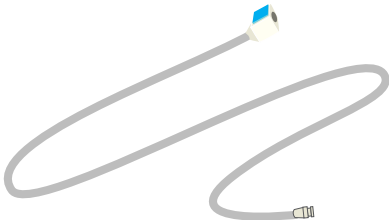

14 French Foley Catheter



Plastic Kidney Dish



Augmented Reality Mat

60131

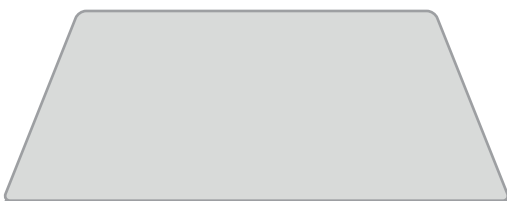

SAFETY & CLEANING INSTRUCTIONS

READ THE SAFETY INSTRUCTIONS CAREFULLY BEFORE USING YOUR CATHETERIZATION TRAINER

DO's



Follow all instructions. Keep these instructions. Pay attention to all warnings.

Only use attachments/accessories specified by Limbs & Things.



Refer all servicing to qualified service personnel. Servicing is required when the apparatus has been damaged.

Wear gloves at all times and remove all jewellery items. Sharp surfaces such as finger nails and rings can lead to damage of silicone parts.



Use lubrication when inserting catheter.

Use only the Milton Antifungal agent supplied to sterilize water.



Use 14 French Foley catheter (male length).

Drain all water from the product and clean with a damp, soft cloth or sponge, using only warm water with mild detergent.



DON'Ts



Do not install near any heat sources, do not expose the product to flames or use near naked flame sources. Do not use flammable solvents near or on this product.

Do not set up the product near electrical appliances or items damaged by water.



Do not leave catheters inserted in the Trainer.

Do not attempt to remove a catheter which has an inflated balloon.

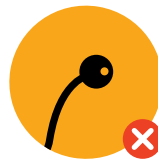

Do not use anaesthetic gel – use mock gel supplied with trainer.

Do not disassemble the product or attempt to repair a faulty unit. Please return the product to Limbs & Things for assessment and repair.



Do not leave trainer set up with water in. Disassemble & clean after every use.

STORAGE & TRANSPORTATION



Always ensure that the product is properly packed and secured during transportation and storage in order to prevent personal injury or damage to the product.

1

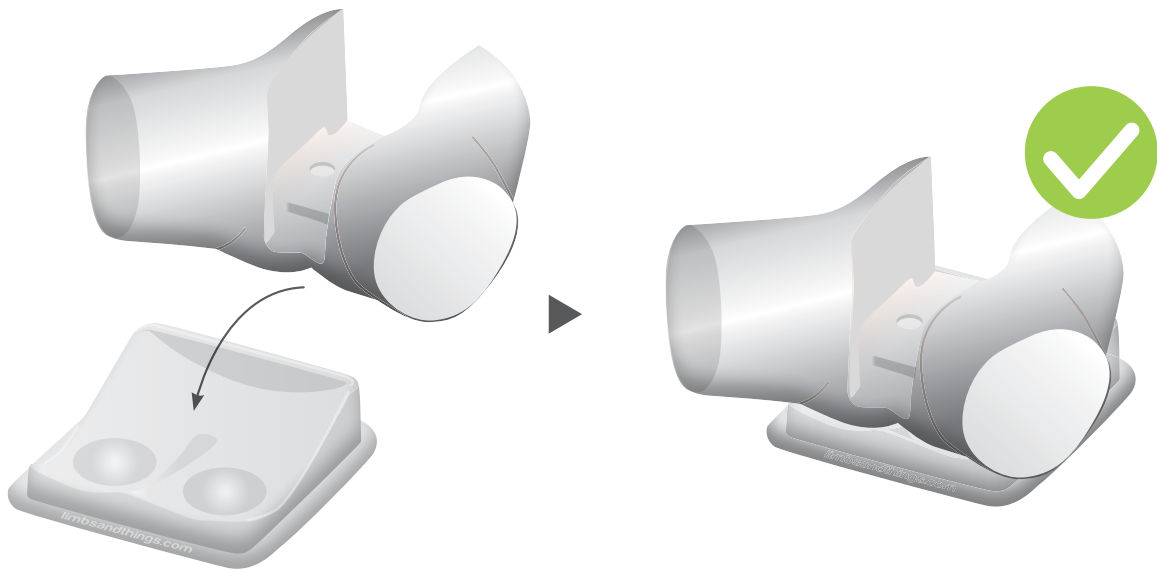

2

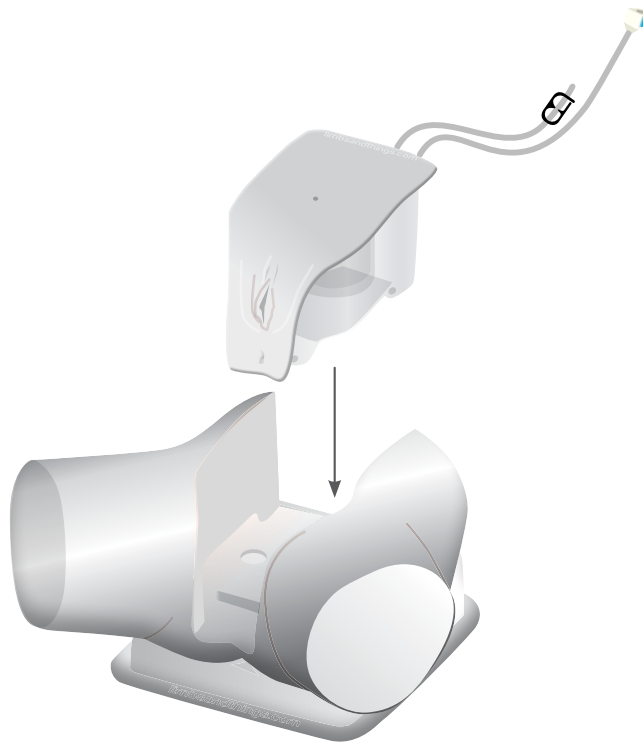

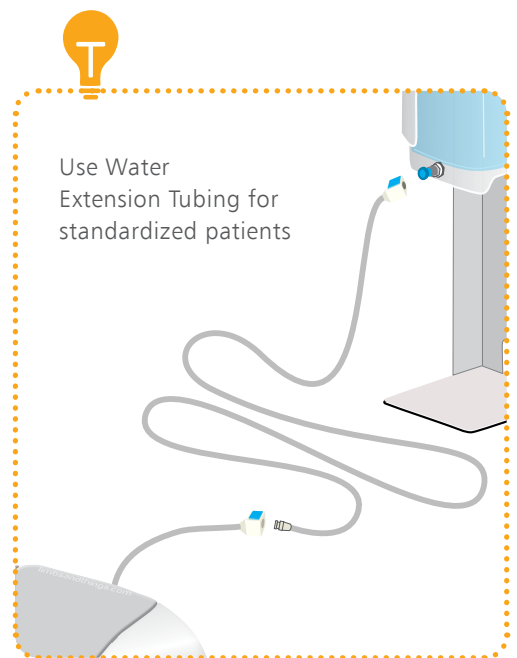
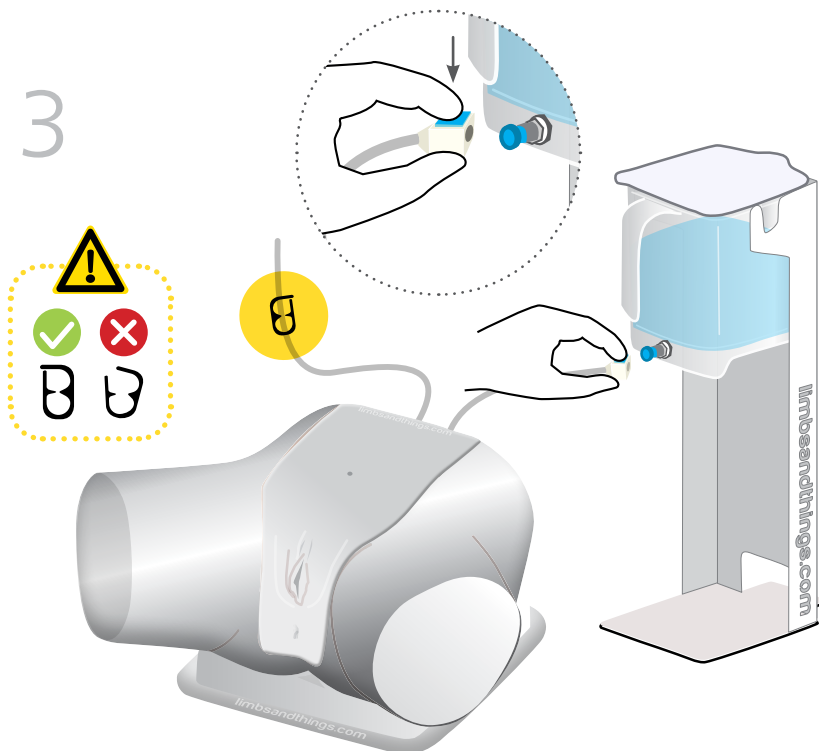
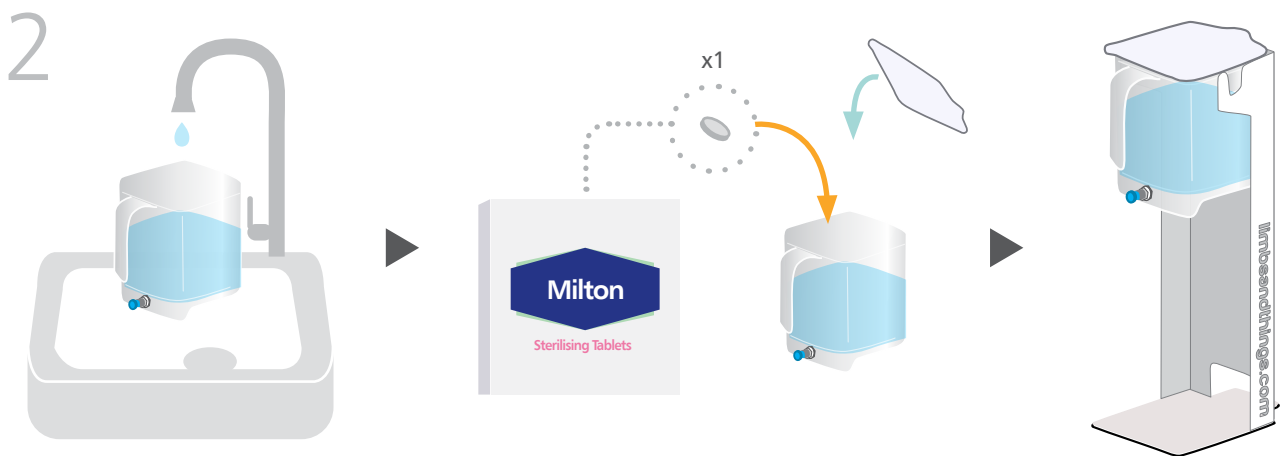
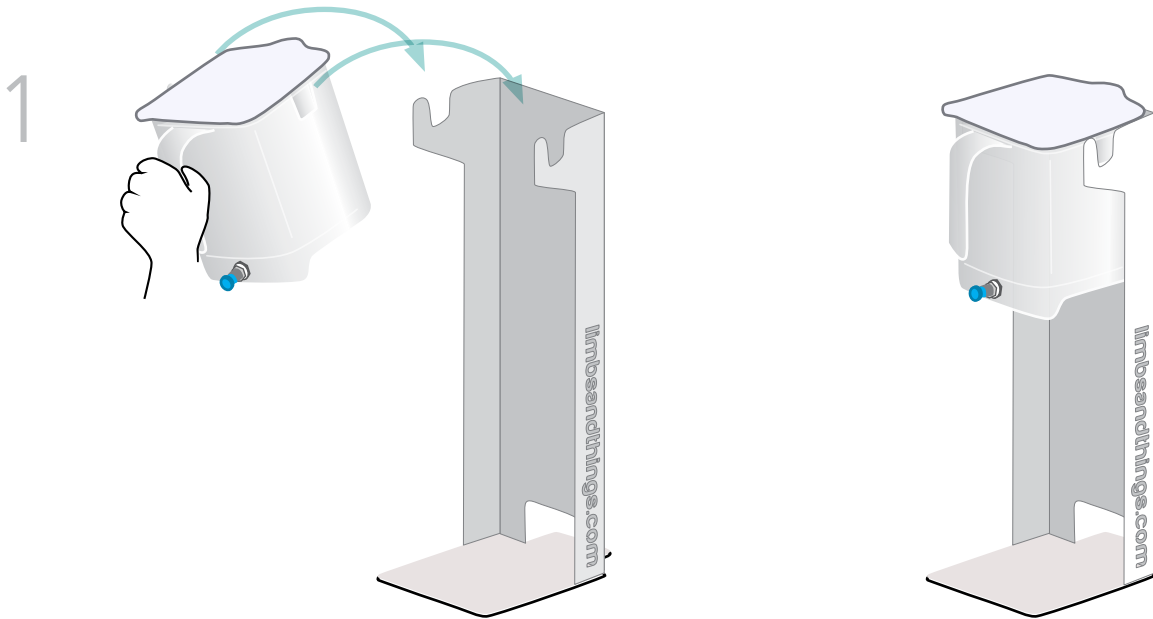

SET UP

ASSEMBLING THE WATER SYSTEM

4

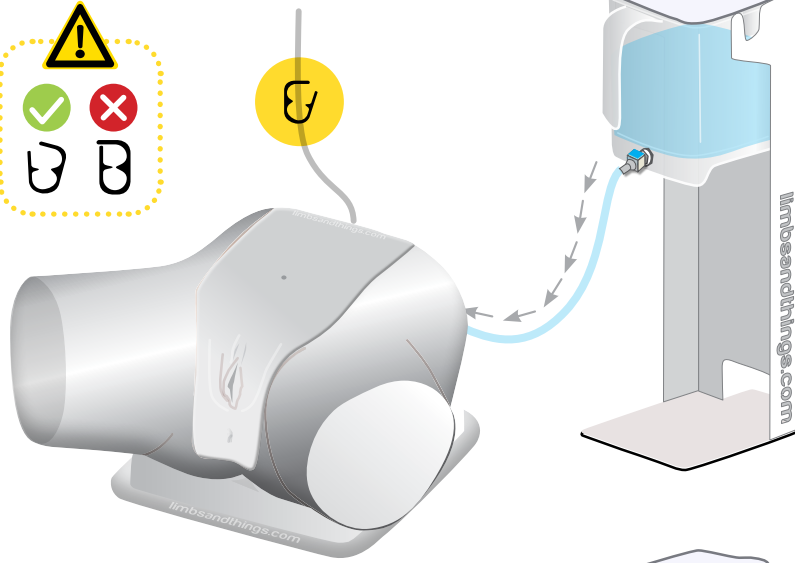

5

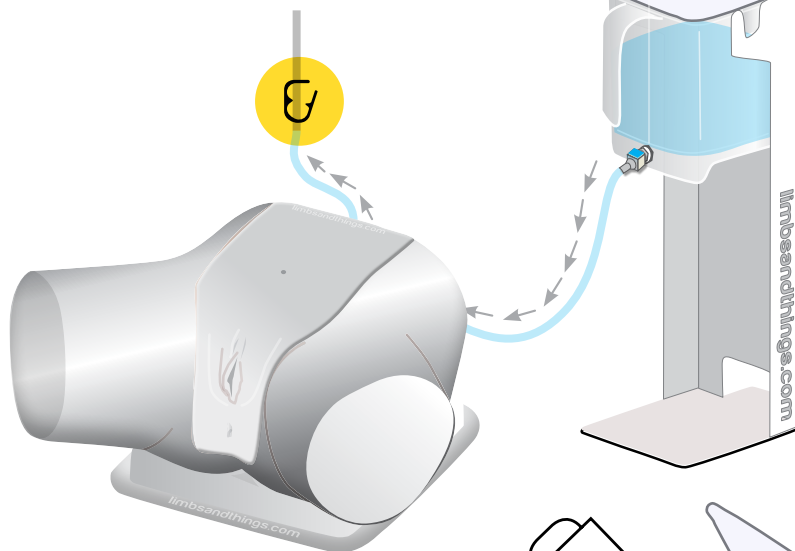

6

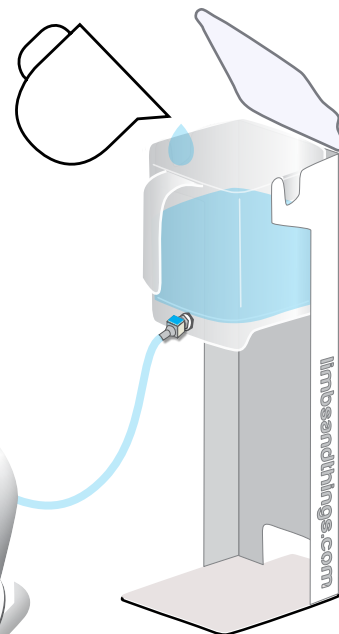

Keep water reservoir topped up



10ml during set up.
5-10ml per catheter
insertion

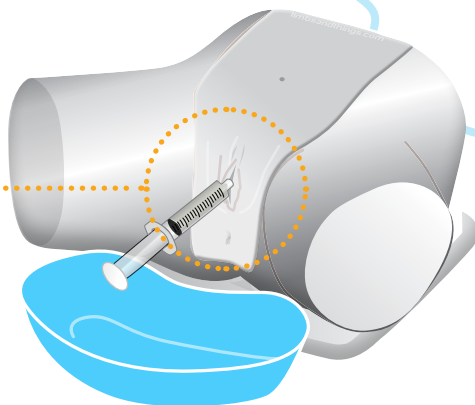

1

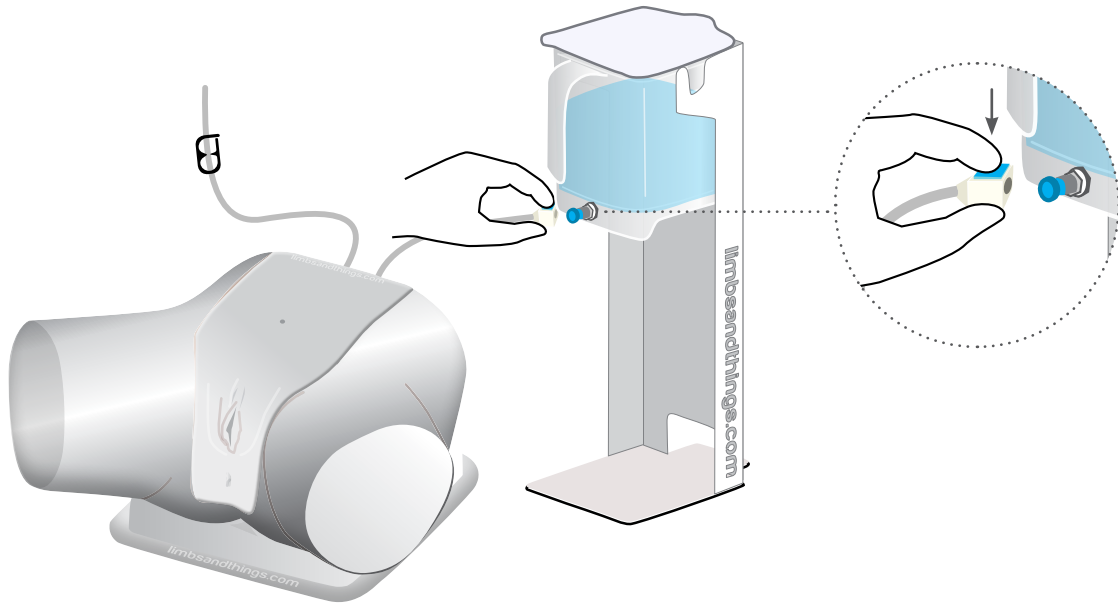

2

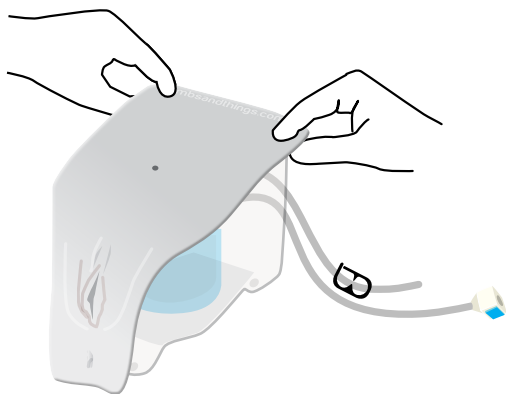

3

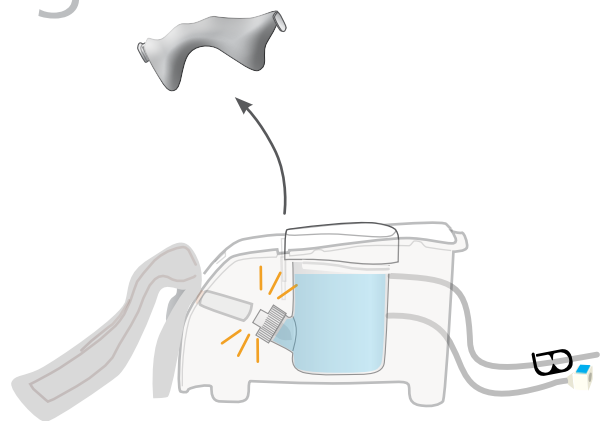

4

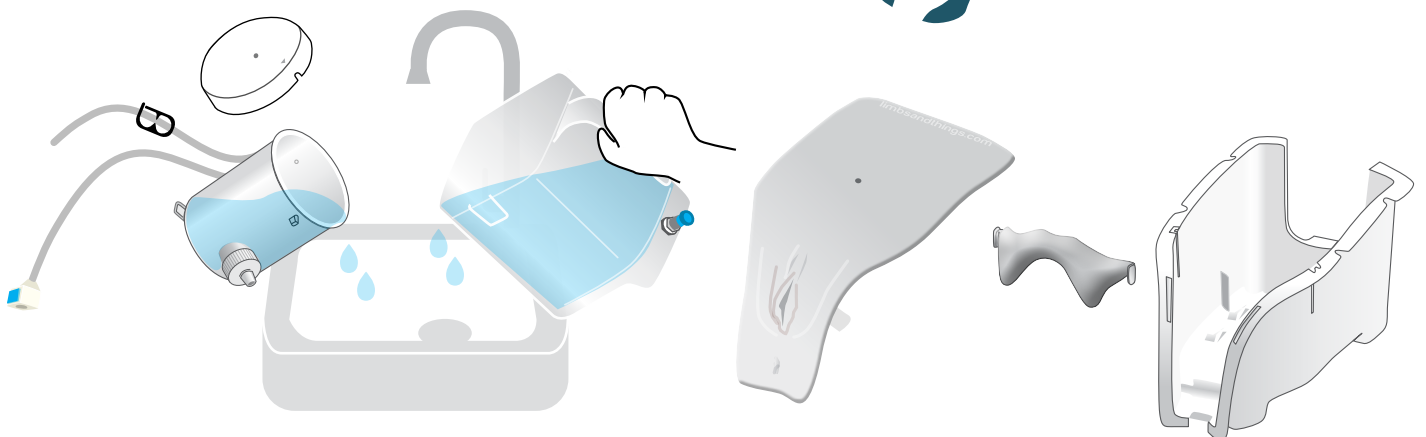

1

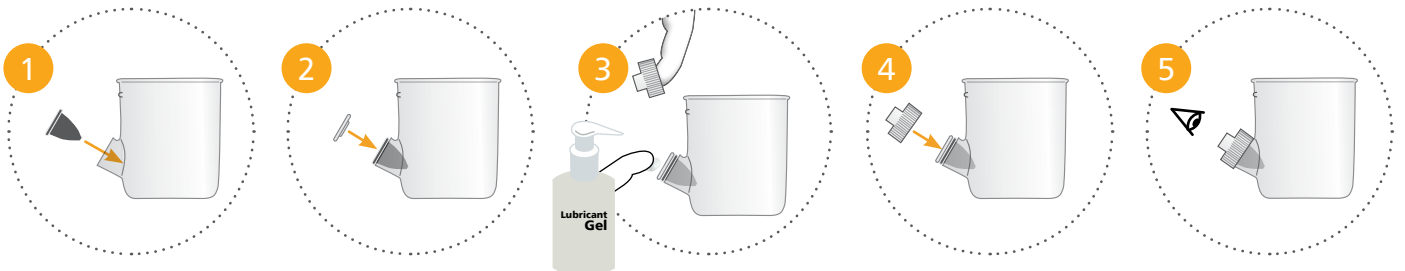
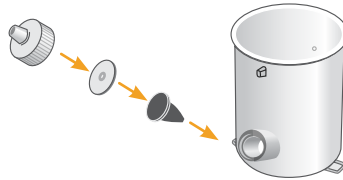

T
Add lubrication to diaphragm before replacing lid

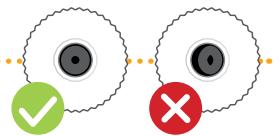

2

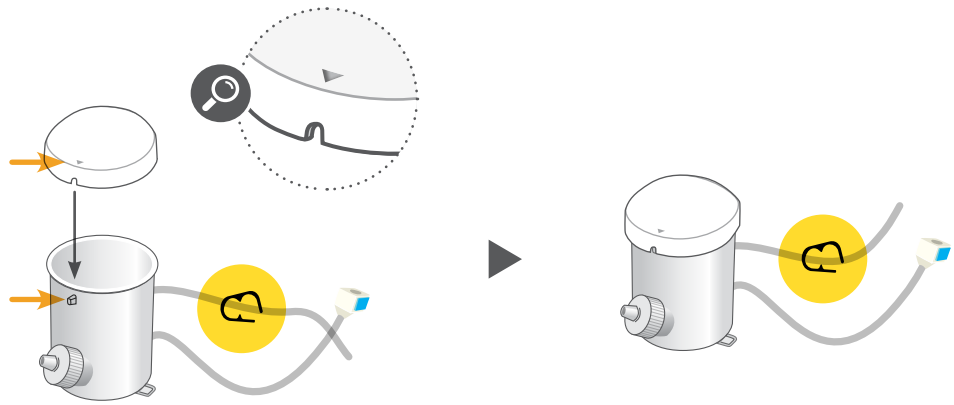

3

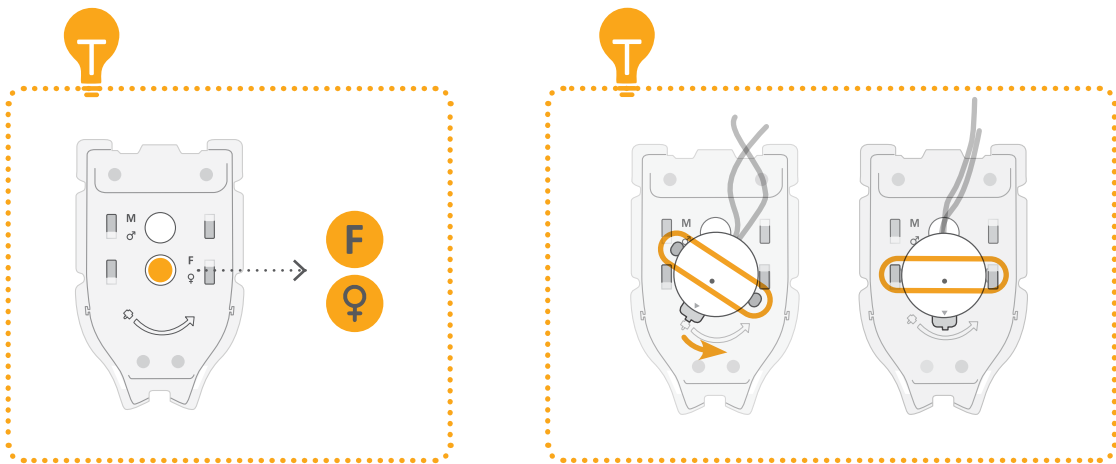
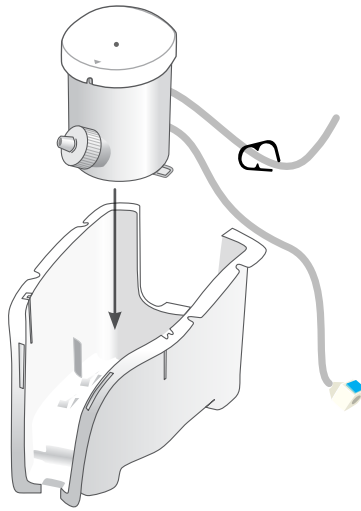

4

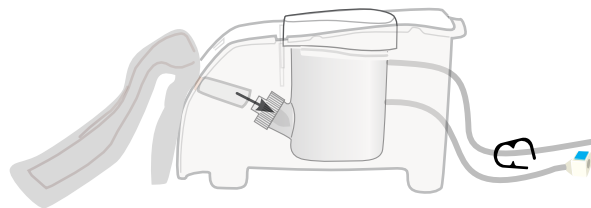

5

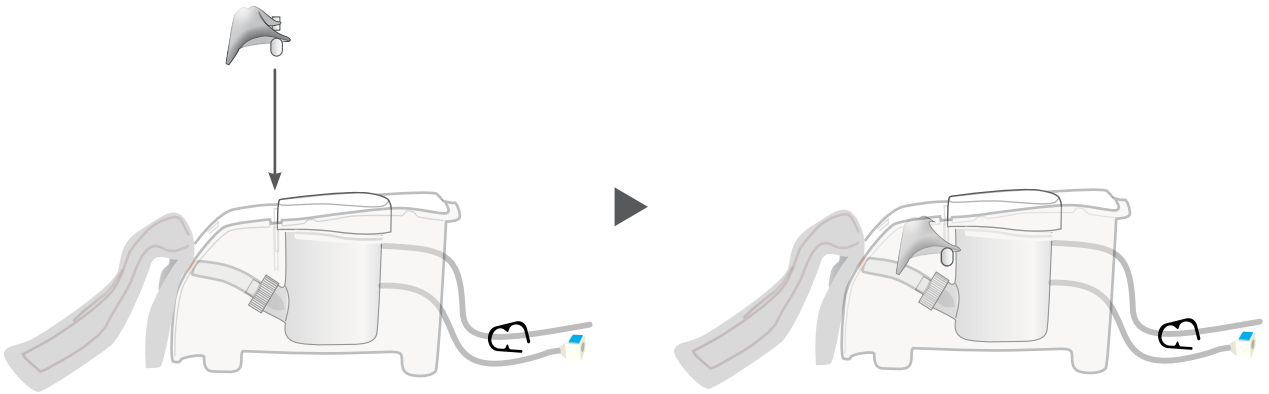

6

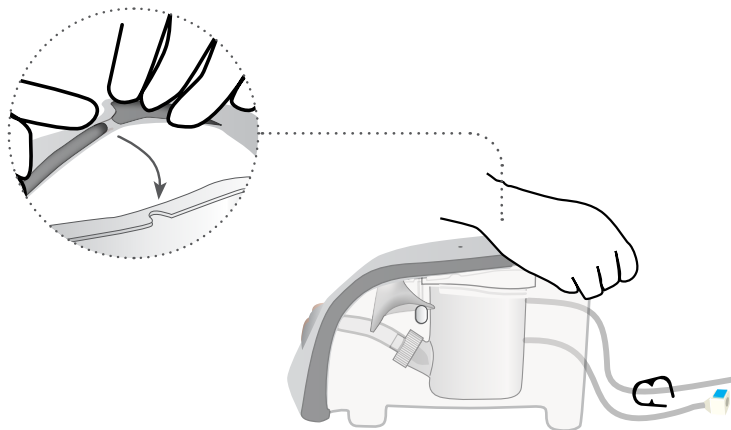



AUGMENTED REALITY TRAINING

for your Catheterization Trainer

SAFETY & CLEANING INSTRUCTIONS

Read the safety instructions carefully before using your Augmented Reality Mat

DO's



Follow all instructions. Keep these instructions. Pay attention to all warnings.



Use mat on flat surface

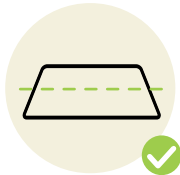

Only use attachments/accessories specified by Limbs & Things



Refer all servicing to qualified service personnel. Servicing is required when the apparatus has been damaged



DON'Ts



Do not install near any heat sources, expose the product to flames or use near naked flame sources. Do not use flammable solvents near or on this product

Do not set up the product near electrical appliances or items damaged by water



Do not cover the graphic of the mat with other items

Do not move the mat with a model on top of it



STORAGE



Store rolled up with print on the outside



Don't fold

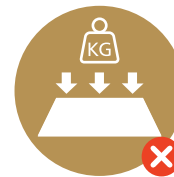

Don't place heavy objects on top

CLEANING



Can be cleaned with water, soap, and non-alcoholic cleaning agents



Avoid abrasive and alcoholic cleaning agents



Make sure mat is dry before storing

AUGMENTED
REALITY SET UP

1

Take the mat out of tube

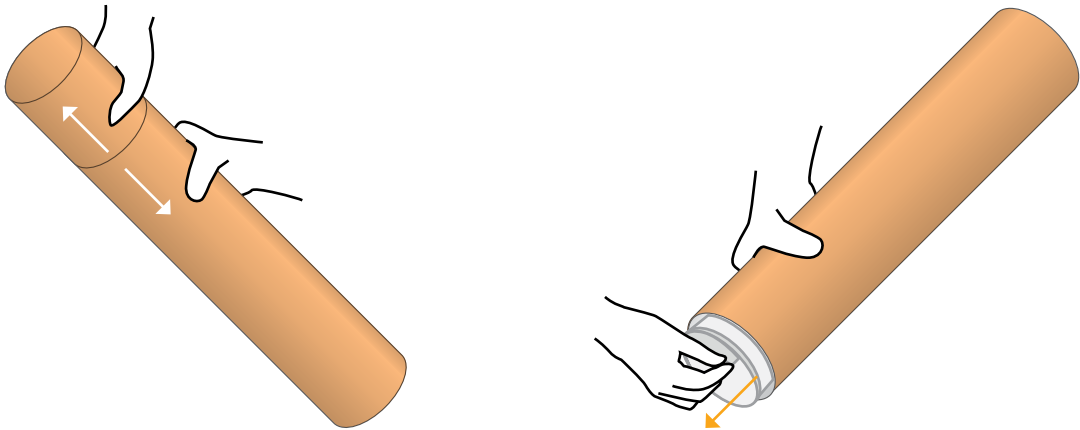

2

Place the mat on a table

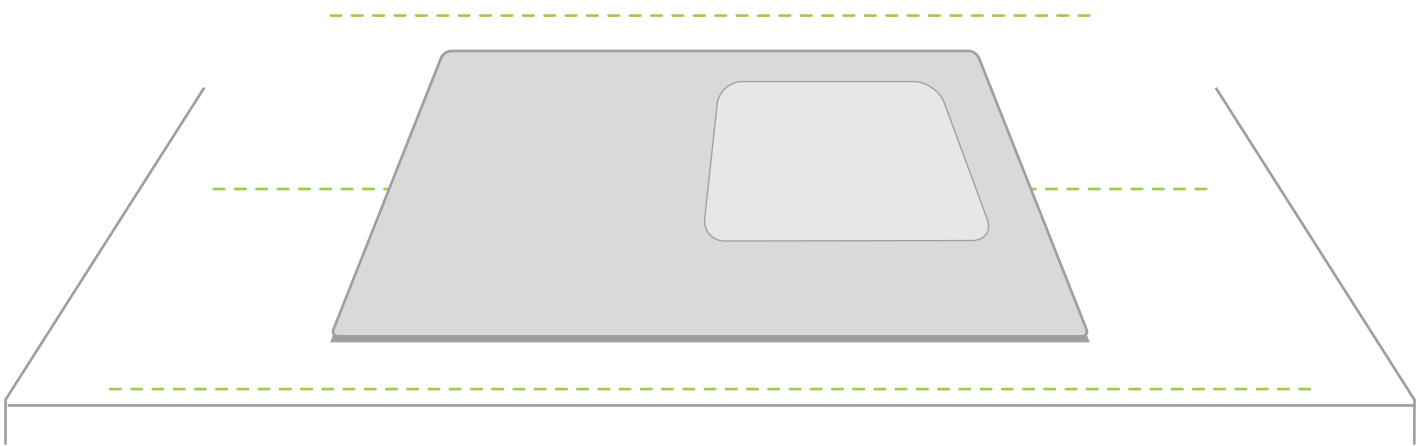

Note: Diagrams are for illustrative purposes, your product may differ from the example shown

3

Place the model on the designated area of the mat

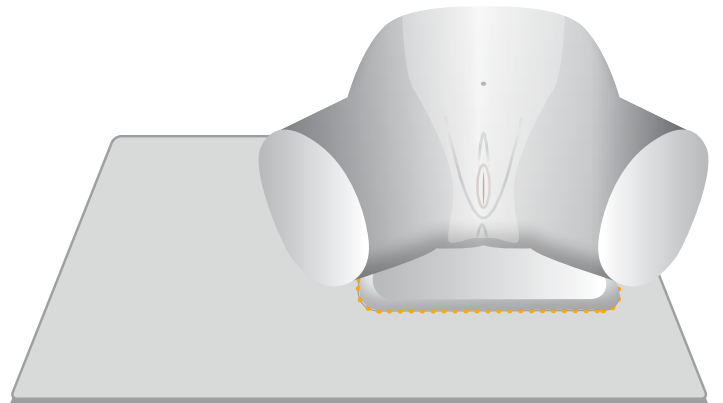
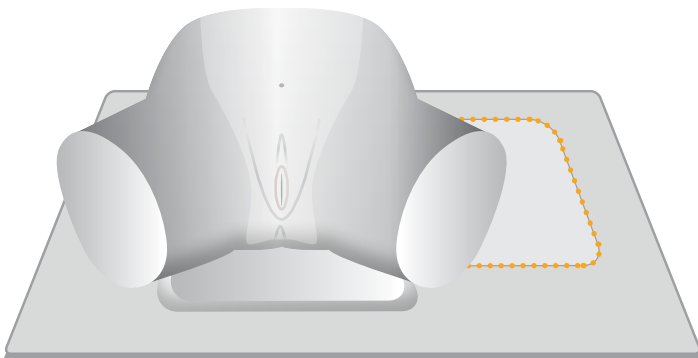
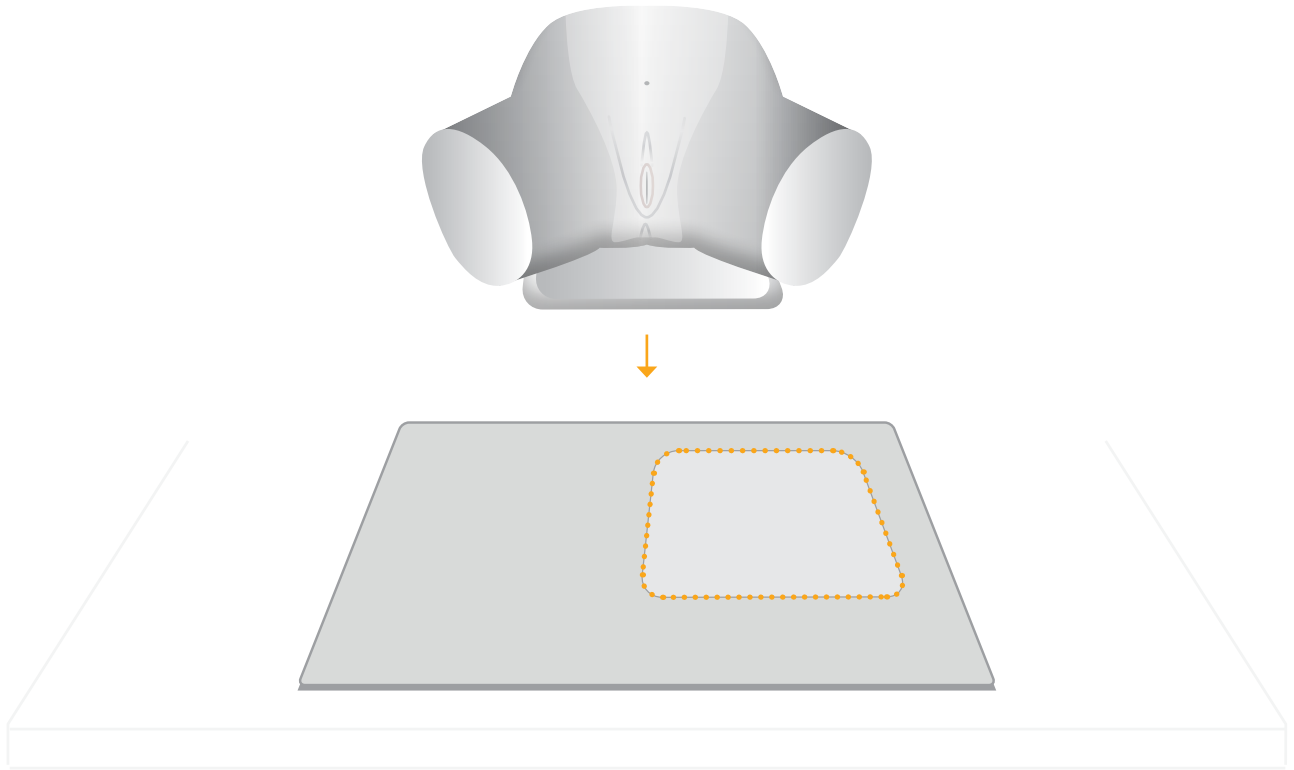

Note: Diagrams are for illustrative purposes, your product may differ from the example shown

Use the L&T Augmented Reality app to scan the mat

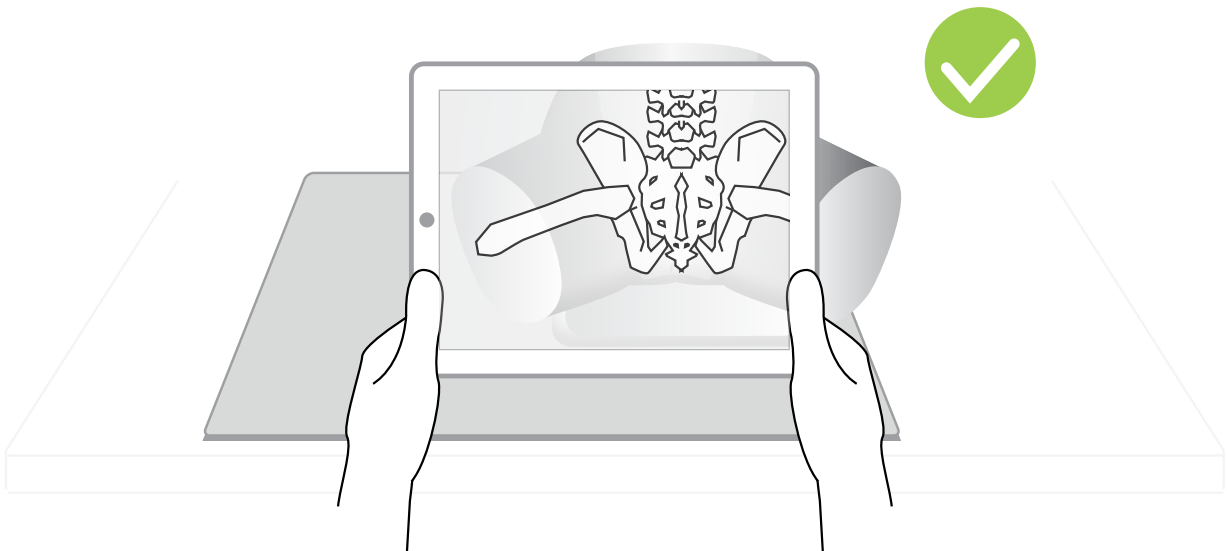
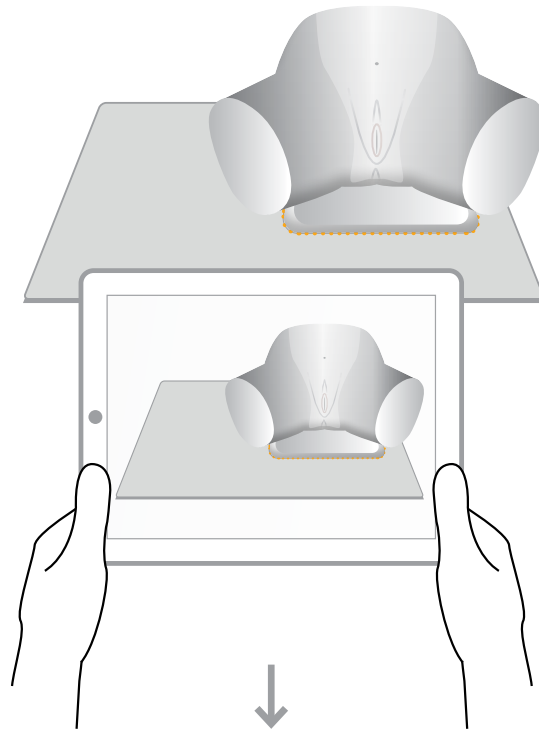

For app troubleshooting please visit the website.

Note: Diagrams are for illustrative purposes, your product may differ from the example shown

YOU MAY
ALSO BE
INTERESTED IN...

MALE
CATHETERIZATION
TRAINER

60850

60870

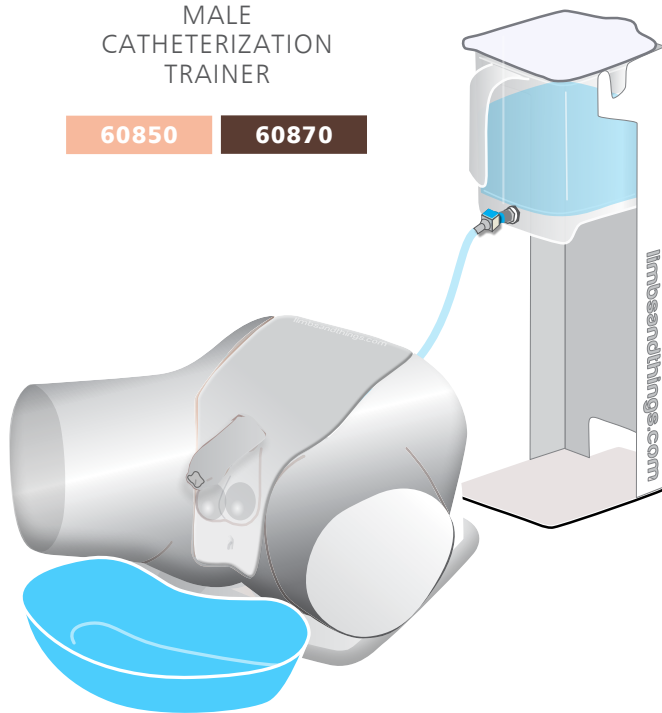

SUPRAPUBIC
INSERTION UNIT

60852

60873

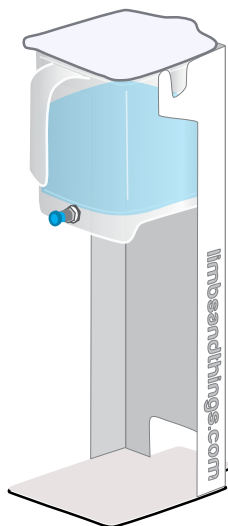
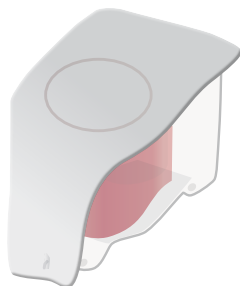

MEDIUM
CARRY CASE

40209



limbs &
things

Part No: 965-509

Issue 08, February 2026
© 2026 Limbs & Things



FM 818255