

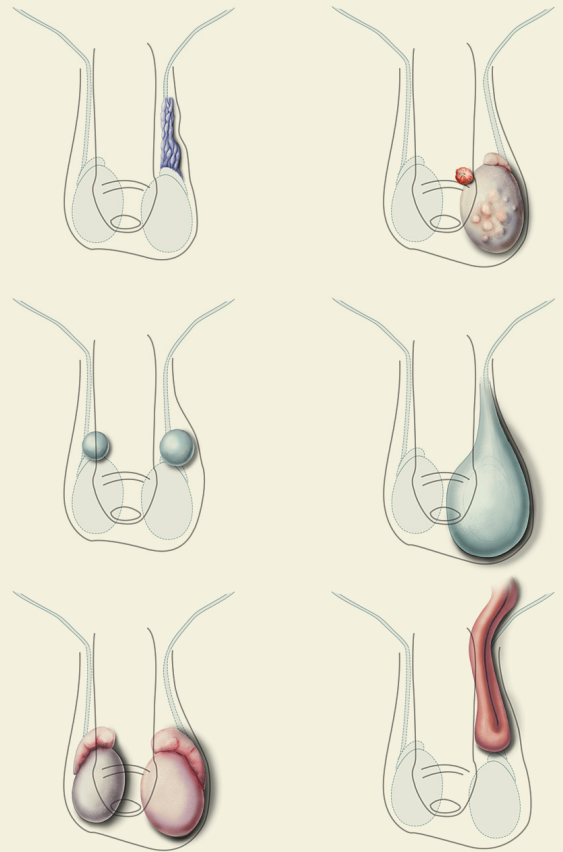

USER GUIDE



CLINICAL MALE PELVIC TRAINER (CMPT)

ADVANCED

This product is available
in light and dark skin tones

60951

60965

FOR MORE SKILLS TRAINING PRODUCTS VISIT

limbsandthings.com

Sussex Street, St Philips, Bristol, BS2 0RA, UK | sales@limbsandthings.com | +44 (0) 117 311 0500

INDEX

PACKAGE SUPPLIED	3
SAFETY & CLEANING INSTRUCTIONS	4
SET UP	5
• SETTING UP THE CMPT	5
• ATTACHING THE FORESKIN	6
TRAINING	7
• STANDING & SUPINE	7
CLEANING & STORAGE	7
• CLEANING & STORAGE AFTER USE	7
AUGMENTED REALITY TRAINING (ART)	8
• SAFETY & CLEANING INSTRUCTIONS	8
• ART SET UP	9



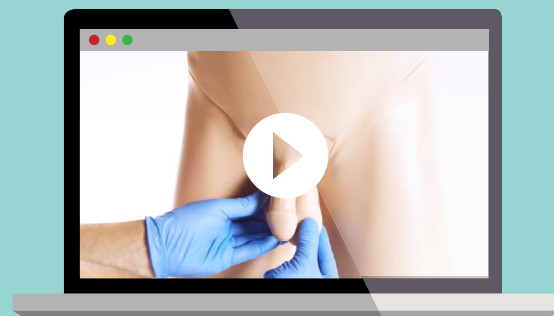



TAKE A LOOK
AT OUR **VIDEO**



VISIT THE WEBSITE
limbsandthings.com

OR YOUTUBE CHANNEL
youtube.com/limbsandthings

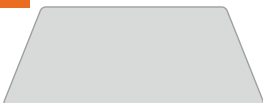
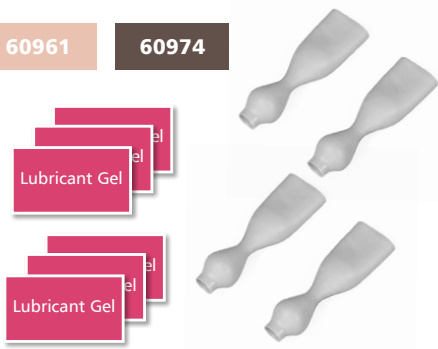
PACKAGE
SUPPLIED

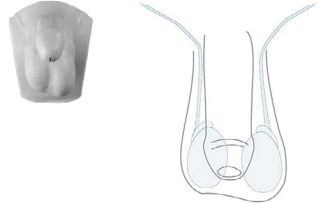
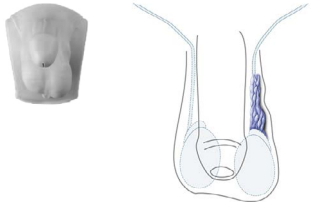
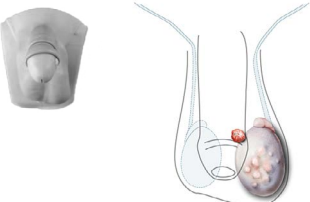
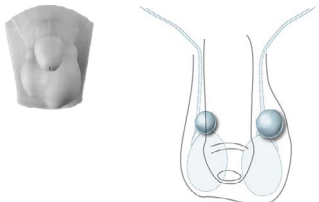
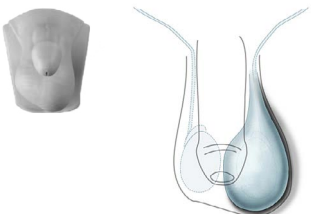
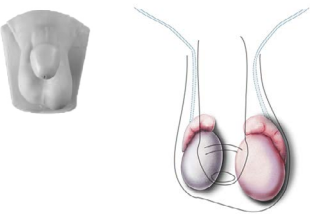
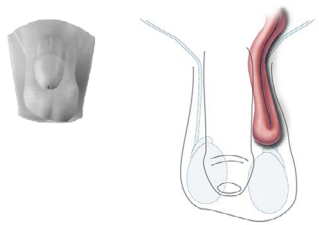
<p>CMPT Abdominal Insert</p> <p>60959 60973</p> 	<p>Lower Torso</p> 	<p>Base</p> 	<p>Carry Case</p> 
		<p>LED Pen Torch</p> 	<p>ART Mat</p> <p>60135</p> 
<p>CMPT Foreskins (x4)</p> <p>60961 60974</p> <p>Lubricant Gel</p> 	<p>CMPT Pubic Bone (x2)</p> <p>60960</p> 	<p>CMPT Module 1: Normal</p> <p>60952 60966</p> 	
<p>CMPT Module 2: Varicocele</p> <p>60953 60967</p> 	<p>CMPT Module 3: Tumours</p> <p>60954 60968</p> 	<p>CMPT Module 4: Epididymal Cysts</p> <p>60955 60969</p> 	
<p>CMPT Module 5: Hydrocele</p> <p>60956 60970</p> 	<p>CMPT Module 6: Epididymo-orchitis</p> <p>60957 60971</p> 	<p>CMPT Module 7: Indirect Inguinal Hernia</p> <p>60958 60972</p> 	

SAFETY & CLEANING INSTRUCTIONS

READ THE SAFETY INSTRUCTIONS CAREFULLY BEFORE USING YOUR CLINICAL MALE PELVIC TRAINER

DO's



Follow all instructions. Keep these instructions. Heed all warnings.

Only use water-based lubricant sachets, such as the ones supplied with this model.



Wear gloves at all times and remove all jewellery items. Sharp surfaces such as finger nails and rings can lead to damage of silicone parts.

Clean the product with a damp soft cloth or sponge, using only warm water with mild detergent, after every training session.



DON'Ts



Do not install near any heat sources, do not expose the product to flames or use near naked flame sources. Do not use flammable solvents near or on this product.

Do not use any attachments other than those supplied by the manufacturer.



Do not wear any jewellery items.

Do not use if the skin is torn.



Do not disassemble the product or attempt to repair a faulty unit, please return the product to Limbs & Things for assessment and repair.

STORAGE & TRANSPORTATION



Always ensure that the products are properly packed and secured during transportation and storage in order to prevent personal injury or damage to the product.

SET UP

SETTING UP THE CMPT

1 Select CMPT Module

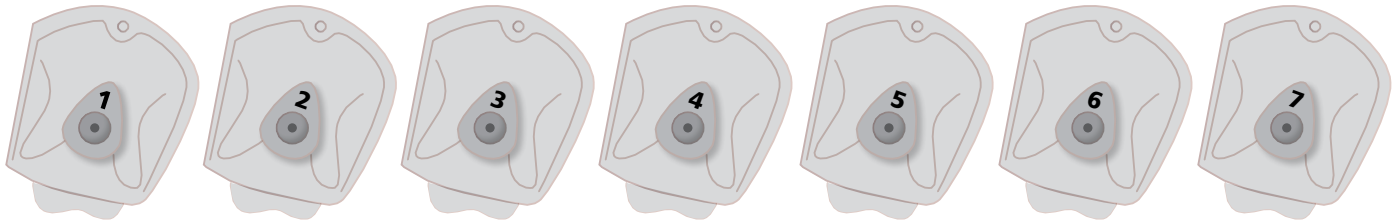

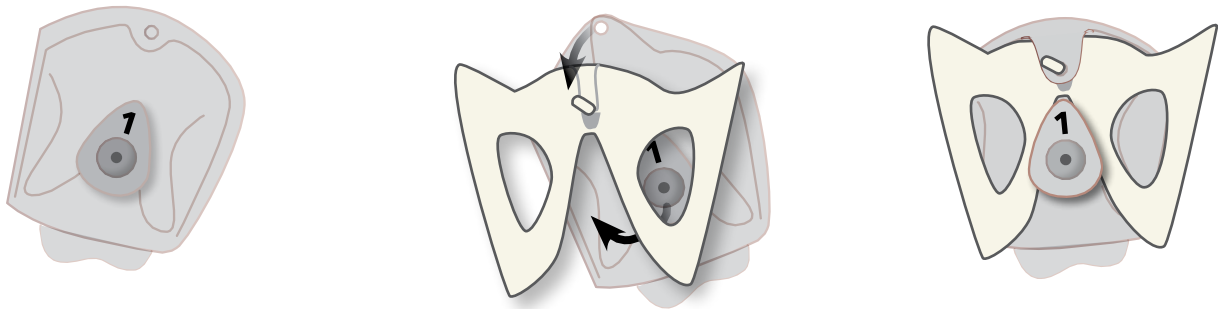

CMPT Modules - Rear view

2 Removing/Attaching CMPT Module to Pubic Bone

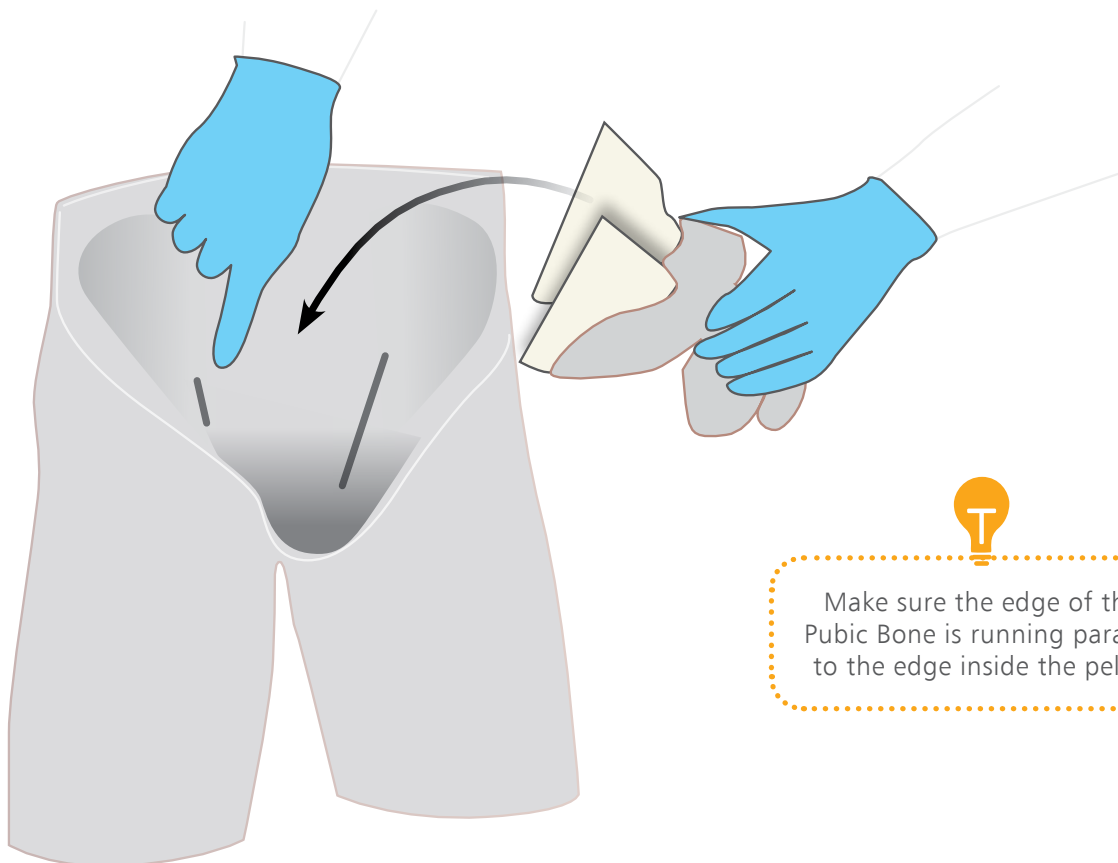

3 Fitting CMPT Module and Pubic Bone assembly in the Lower Torso



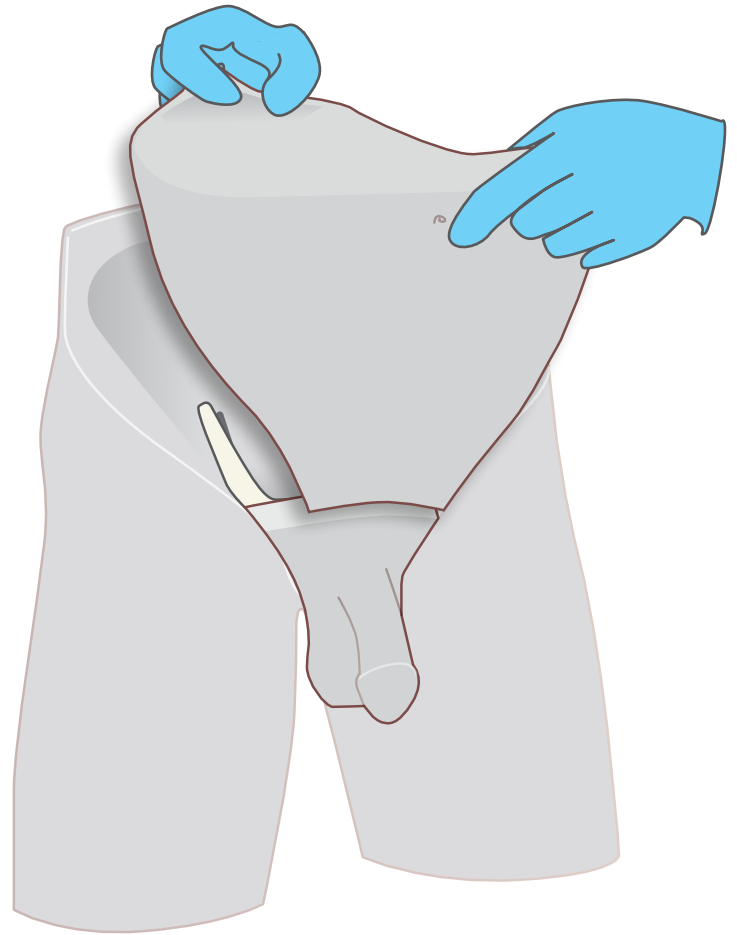
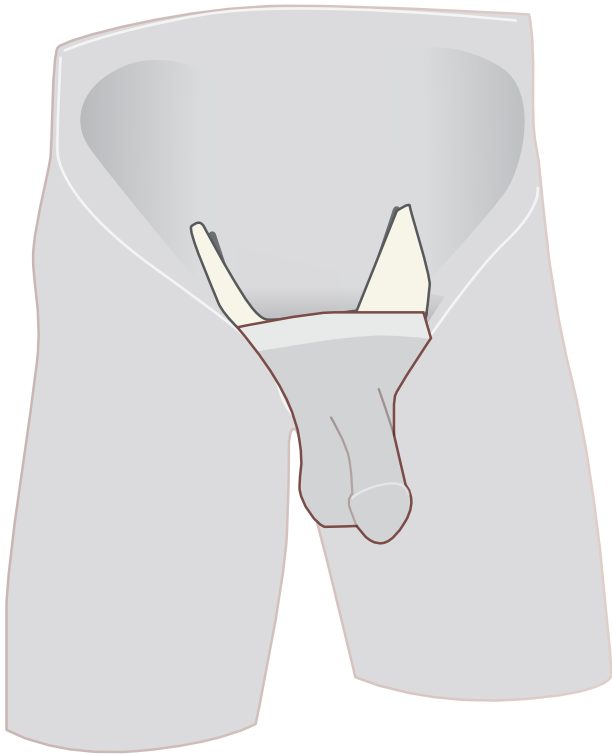

Make sure the edge of the Pubic Bone is running parallel to the edge inside the pelvis

3 Removing/Attaching Abdominal Insert

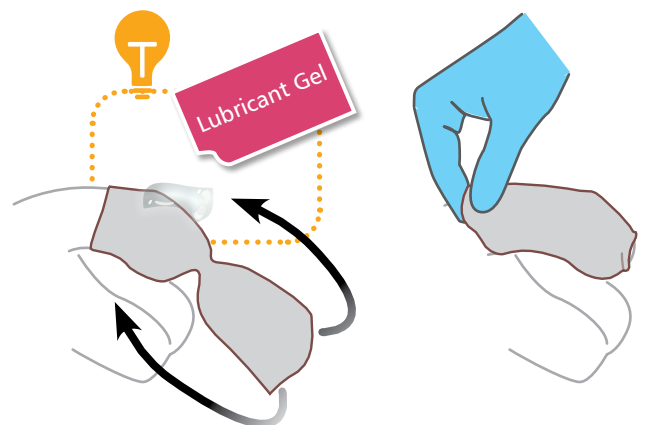
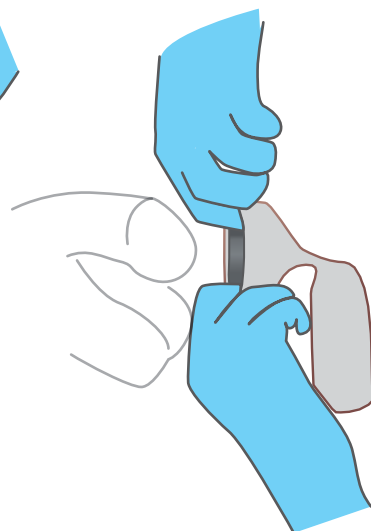
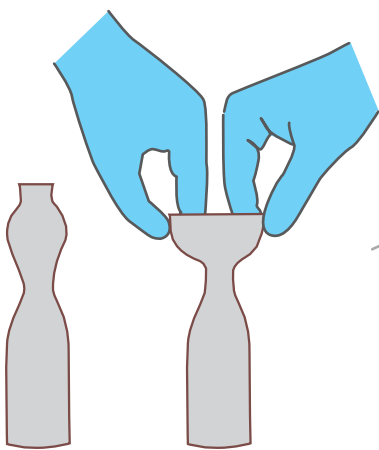

ATTACHING THE FORESKIN



TRAINING

Can be used in 2 positions: standing & supine

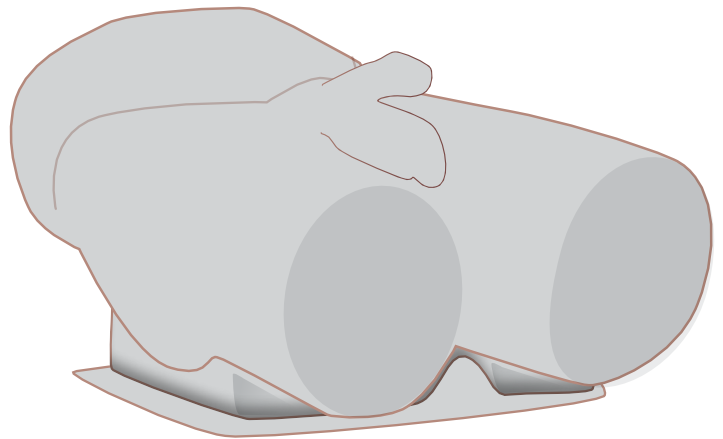
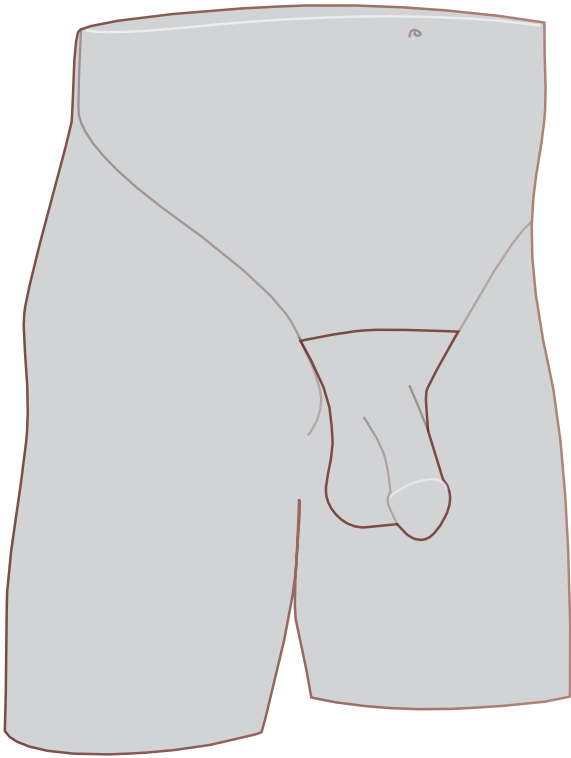

CLEANING & STORAGE

Clean off any surface dirt with a damp, soft cloth, using only warm water and mild detergent

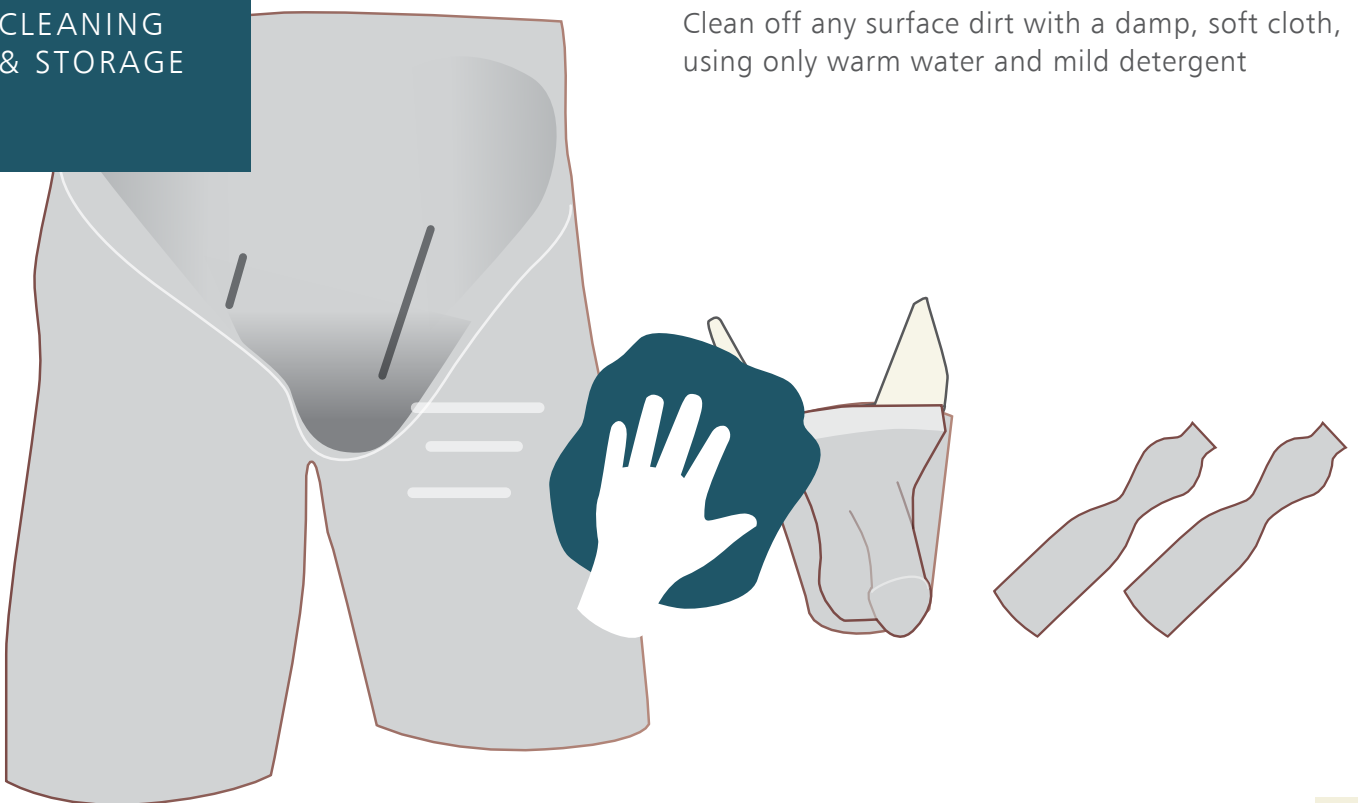



AUGMENTED REALITY TRAINING (ART)

for your CMPT Simulator

SAFETY & CLEANING INSTRUCTIONS

Read the safety instructions carefully before using your ART Mat

DO's



Follow all instructions. Keep these instructions. Heed all warnings

Use mat on flat surface

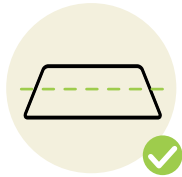

Only use attachments/accessories specified by Limbs & Things

Refer all servicing to qualified service personnel. Servicing is required when the apparatus has been damaged



DON'Ts



Do not install near any heat sources, do not expose the product to flames or use near naked flame sources. Do not use flammable solvents near or on this product

Do not set up the product near electrical appliances or items damaged by water



Do not cover the graphic of the mat with other items

Do not move the mat with a model on top of it



STORAGE



Store rolled up with print on the outside



Don't fold



Don't place heavy objects on top

CLEANING



Can be cleaned with water, soap and non-alcoholic cleaning agents



Avoid abrasive and alcoholic cleaning agents



Make sure mat is dry before storing

ART SET UP

1

Take the mat out of tube

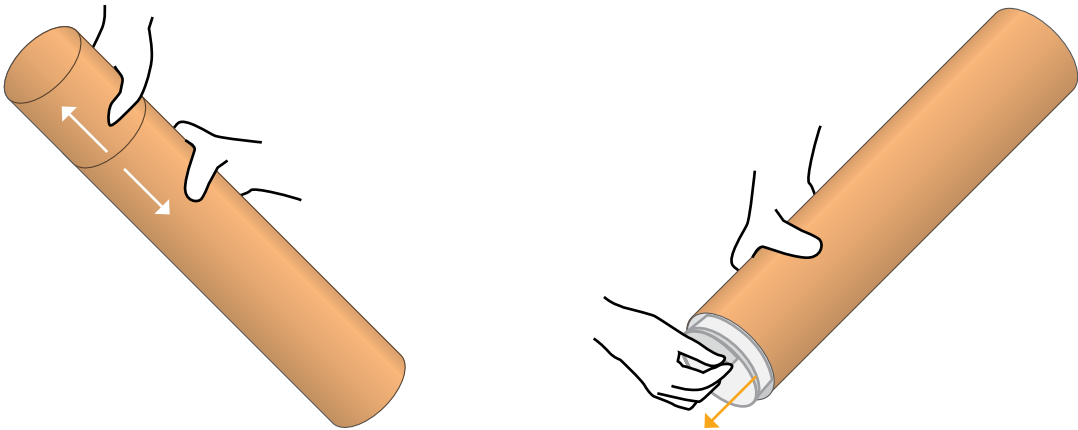

2

Place the mat on a table

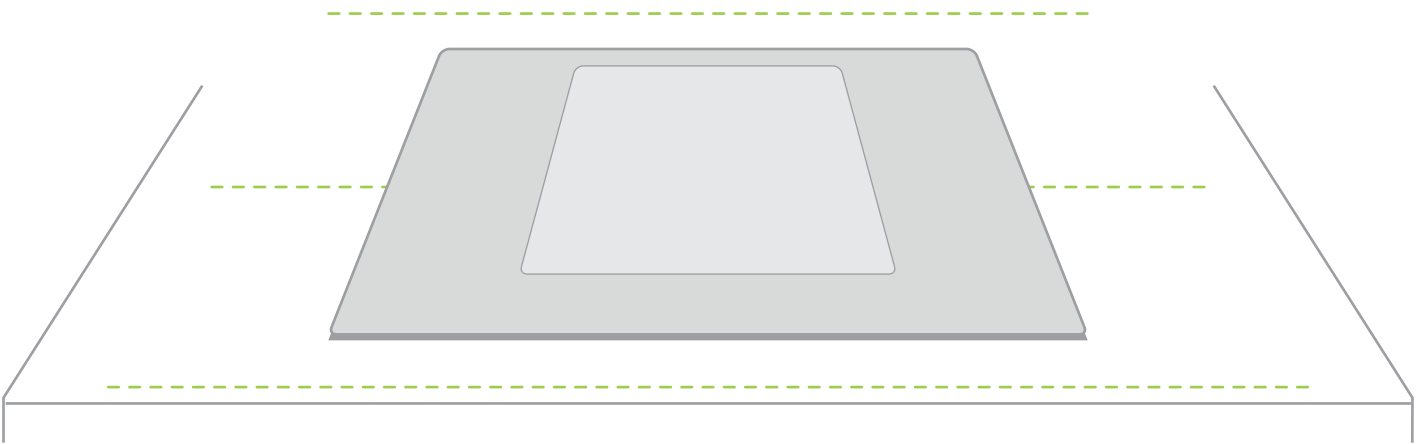

Note: Diagrams are for illustrative purposes, your product may differ from the example shown

3

Place the model on the designated area of the mat

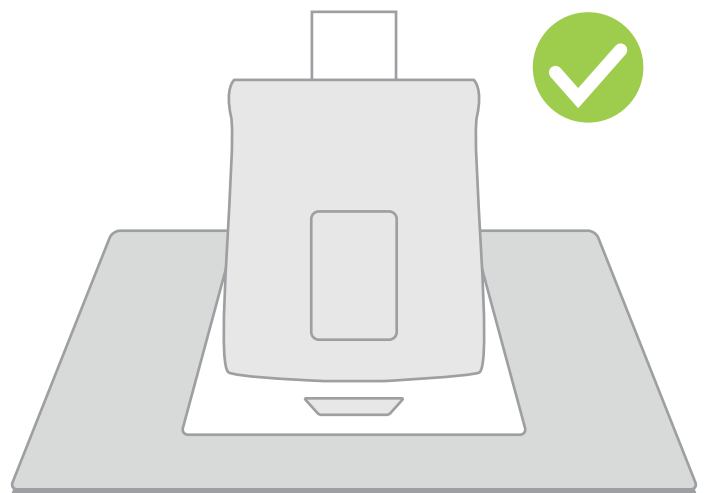
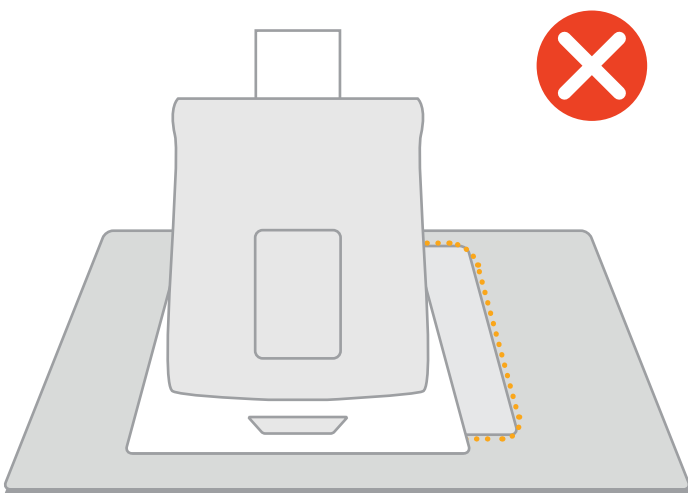
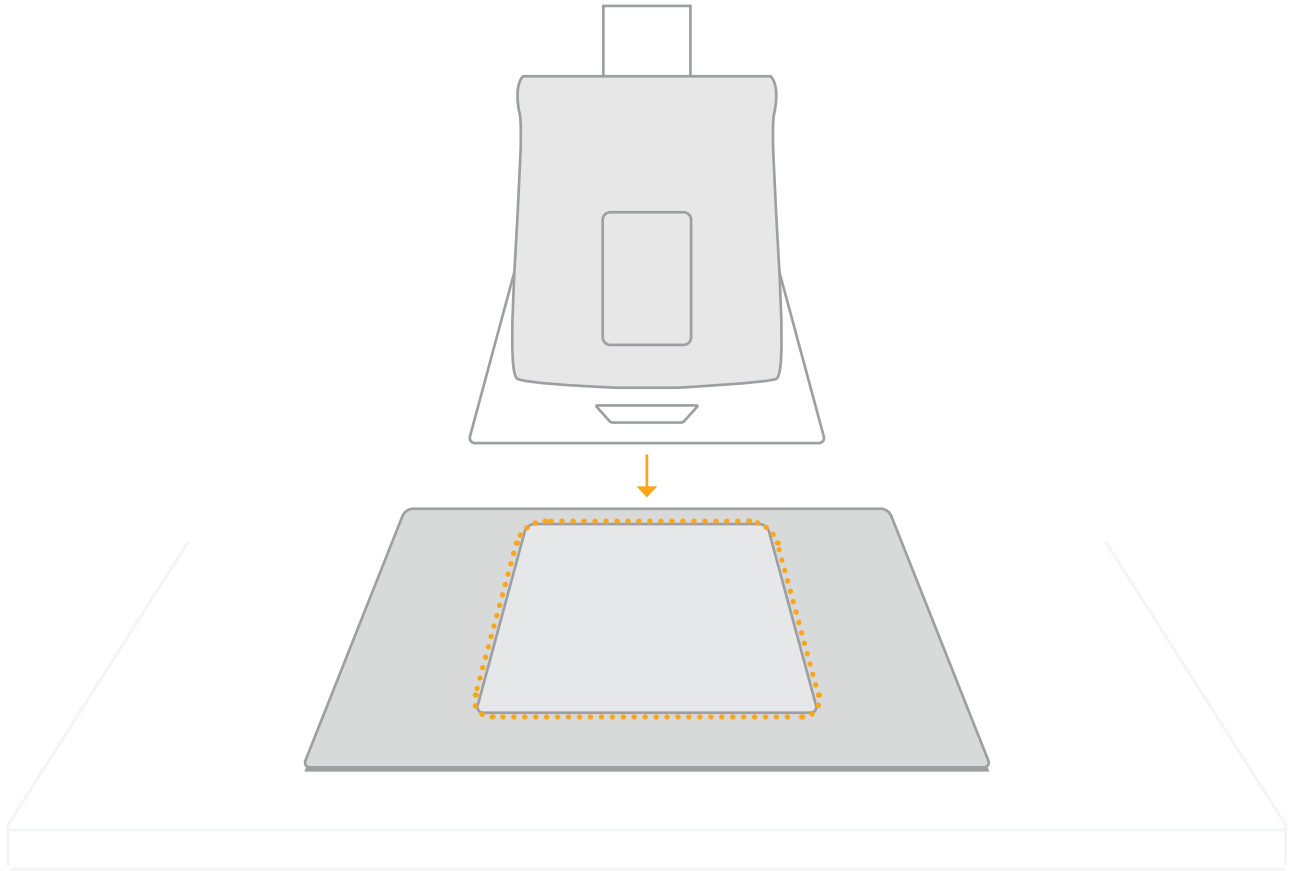

Note: Diagrams are for illustrative purposes, your product may differ from the example shown

Use the A.R.T. app to scan the mat

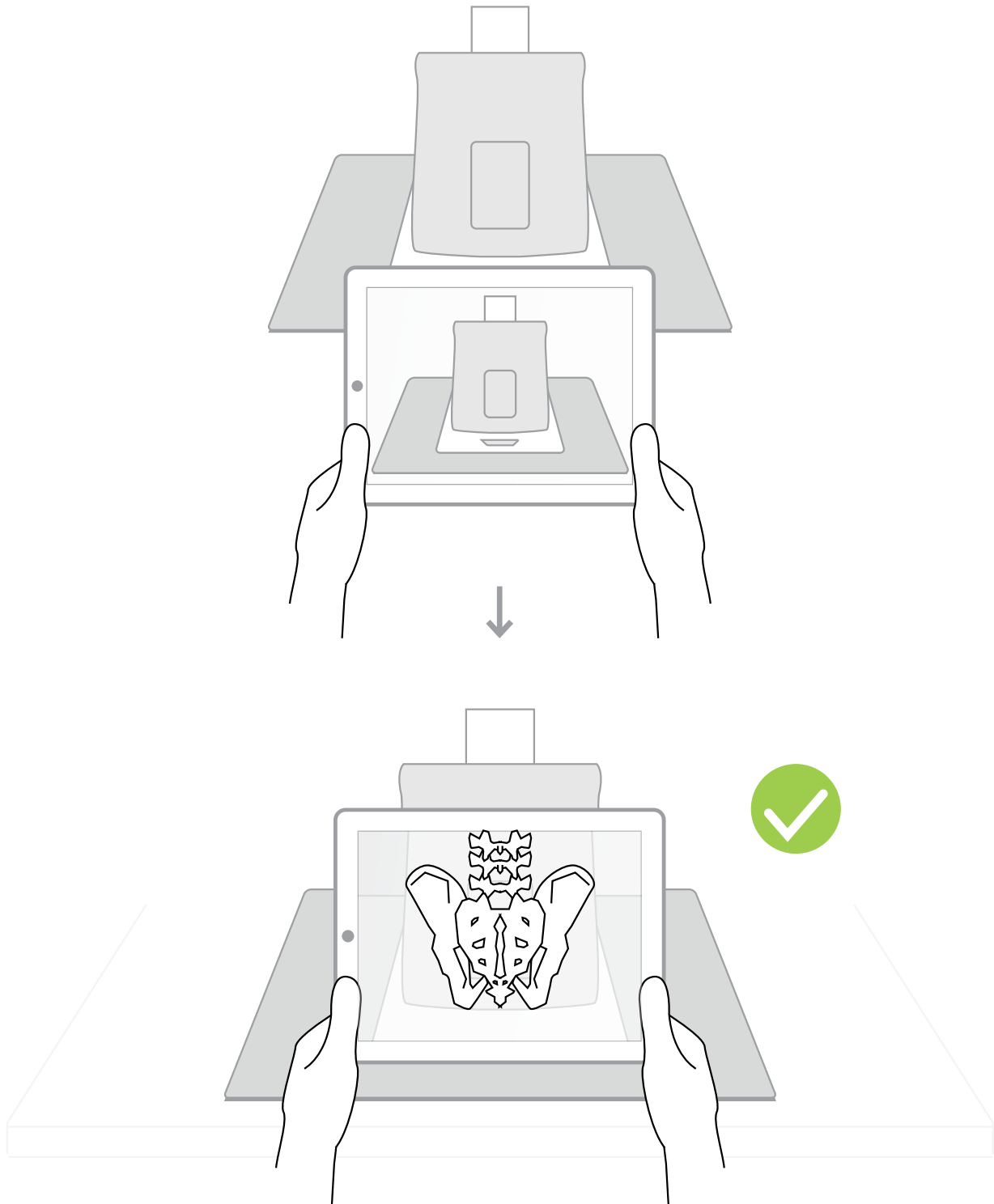

For app troubleshooting please visit the website.

Note: Diagrams are for illustrative purposes, your product may differ from the example shown

YOU MAY
ALSO BE
INTERESTED IN...

MALE RECTAL
EXAMINATION TRAINER
ADVANCED

60171

60187



Part No: 365-001
Issue 3, October 2024
© 2024 Limbs & Things